

GSM3335SF

30V P-Channel MOSFET

Product Description

The P-Channel enhancement mode power field effect transistors are using trench DMOS technology. This advanced technology has been especially tailored to minimize on-state resistance, provide superior switching performance, and withstand high energy pulse in the avalanche and commutation mode.

Features

- $R_{DS(ON)} = 4.8m\Omega @ V_{GS} = -10V$
- $R_{DS(ON)} = 7.8m\Omega @ V_{GS} = -4.5V$
- SOP-8L Package
- RoHS Compliant and Halogen Free

Applications

- Notebook
- Load Switch
- Battery Protection
- Hand-held Instruments

Packages & Pin Assignments

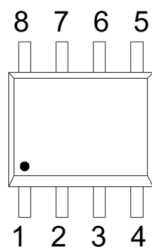
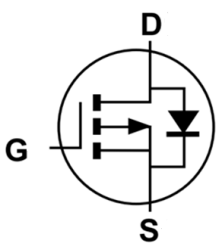
SOP-8L			Equivalent Circuit		
					
Pin	Symbol	Description	Pin	Symbol	Description
1	S	Source	8	D	Drain
2	S	Source	7	D	Drain
3	S	Source	6	D	Drain
4	G	Gate	5	D	Drain

Ordering and Marking Information

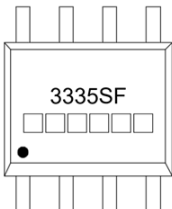
Ordering Information			
Part Number	Package	Part Marking	Quantity / Reel
GSM3335SF	SOP-8L	3335SF □□□□□□	4,000 PCS
GSM3335 1 2			
- Product Code: GSM3335		- Package Code: 1 is S for SOP-8L	
		- Green Level: 2 is F for RoHS Compliant and Halogen Free	
Marking Information			
		- Product Code: 3335SF	
		- GS Code: □□□□□□ • The Dot denotes Pin 1	

Absolute Maximum Ratings (T_J=25°C Unless otherwise noted)

Symbol	Parameter	Value	Unit
V _{DS}	Drain-Source Voltage	-30	V
V _{GS}	Gate-Source Voltage	±20	V
I _D	Continuous Drain Current ³	T _A =25°C	-24
		T _A =70°C	-19
I _{DM}	Pulsed Drain Current ^{1, 3}	-96	A
I _{AS}	Single Pulse Avalanche Current, L = 0.1mH ¹	25	A
E _{AS}	Single Pulse Avalanche Energy, L = 0.1mH ¹	93	mJ
P _D	Power Dissipation	T _A =25°C	3.1
		T _A =70°C	2
R _{θJA}	Max Thermal Resistance-Junction to Ambient (Steady State) ²	75	°C/W
	Max Thermal Resistance-Junction to Ambient (t ≤ 10s) ²	40	
T _J	Operating Junction Temperature Range	-55 to +150	°C
T _{STG}	Storage Temperature Range	-55 to +150	°C

NOTE:

- Pulsed width is limited by the maximum junction temperature.
- Surface mounted on 1in2 FR-4 board with 2oz. Copper.
- The typical thermal Resistance-Junction to Ambient t ≤ 10s is 28°C/W..

Electrical Characteristics (T_J=25°C, unless otherwise specified)

Symbol	Parameter	Test Conditions	Min.	Typ.	Max.	Unit
Static Characteristics						
B _V DSS	Drain-Source Breakdown Voltage	V _{GS} =0V, I _D =-250μA	-30	-	-	V
I _{DSS}	Drain-Source Leakage Current	V _{DS} =-30V, V _{GS} =0V	-	-	-1	μA
I _{GSS}	Gate-Source Leakage Current	V _{DS} =0V, V _{GS} =±20V	-	-	±100	nA
V _{GS(th)}	Gate Threshold Voltage	V _{DS} =V _{GS} , I _D =-250μA	-1.2	-	-2.5	V
R _{DS(ON)}	Drain-Source On-Resistance	V _{GS} =-10V, I _D =-20A	-	4.3	4.8	mΩ
		V _{GS} =-4.5V, I _D =-10A	-	6.3	7.8	
Dynamic Characteristics						
C _{iss}	Input Capacitance	V _{DS} =-15V, V _{GS} =0V, f=1MHz	-	7500	-	pF
C _{oss}	Output Capacitance		-	1200	-	
C _{rss}	Reverse Transfer Capacitance		-	940	-	
Q _g	Total Gate Charge	V _{DS} =-15V, I _D =-10A V _{GS} =-10V	-	150	-	nC
Q _{gs}	Gate-Source Charge		-	28	-	
Q _{gd}	Gate-Drain Charge		-	24	-	
t _{d(on)}	Turn-On Delay Time	V _{DD} =-15V, I _D =-10A V _{GS} =-10V, R _g =6Ω	-	25	-	ns
t _r	Turn-On Rise Time		-	35	-	
t _{d(off)}	Turn-Off Delay Time		-	100	-	
t _f	Turn-Off Fall Time		-	50	-	
Diode Characteristics						
V _{SD}	Diode Forward Voltage	V _{GS} =0V, I _S =1A	-	-	-1	V

Typical Performance Characteristics

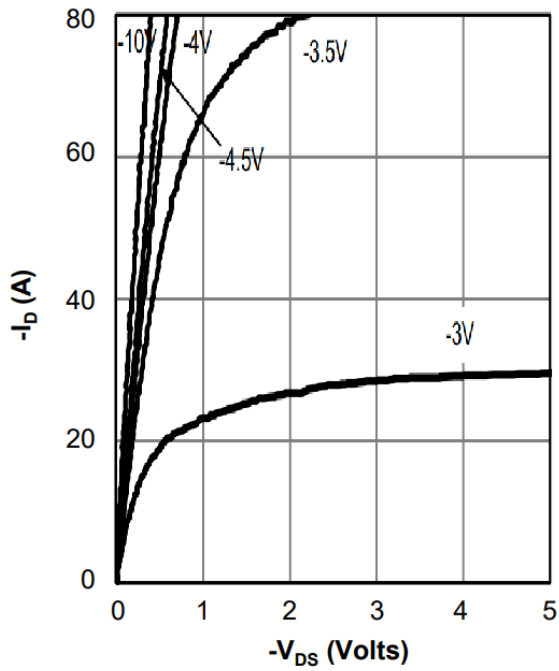

FIG.1 Output Characteristics

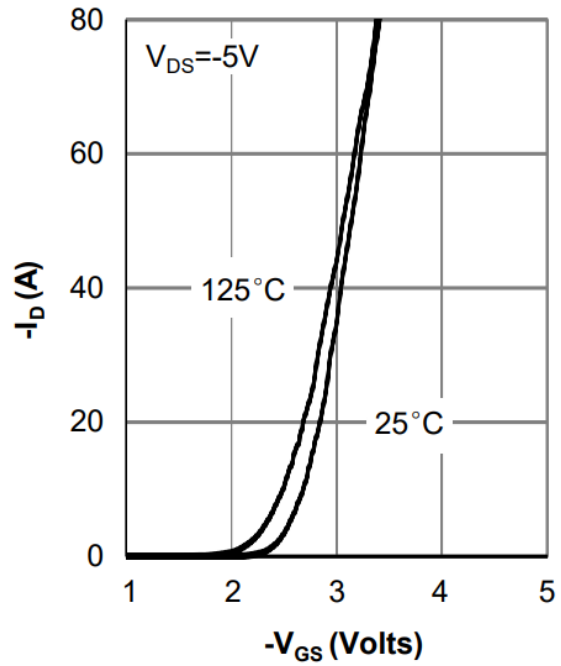

FIG.2 Transfer Characteristics

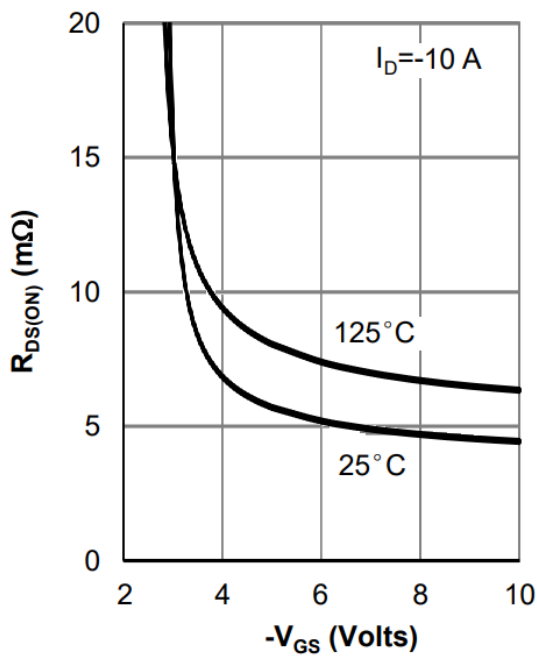

FIG.3 On-Resistance vs. Gate Voltage

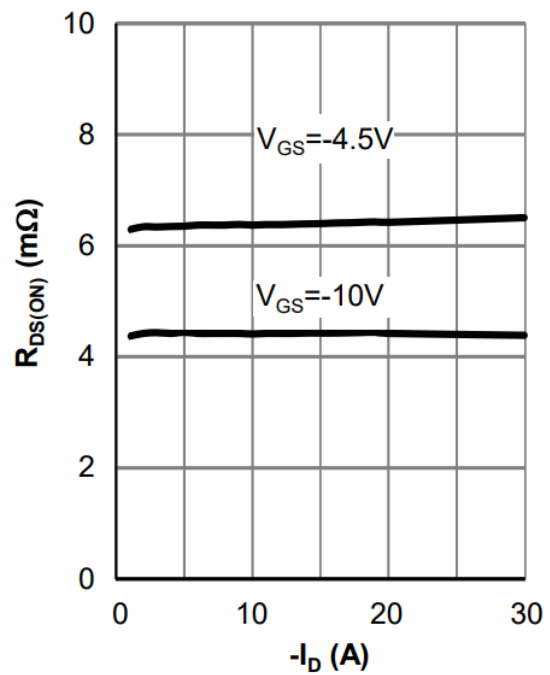

FIG.4 On-Resistance vs. Drain Current

Typical Performance Characteristics

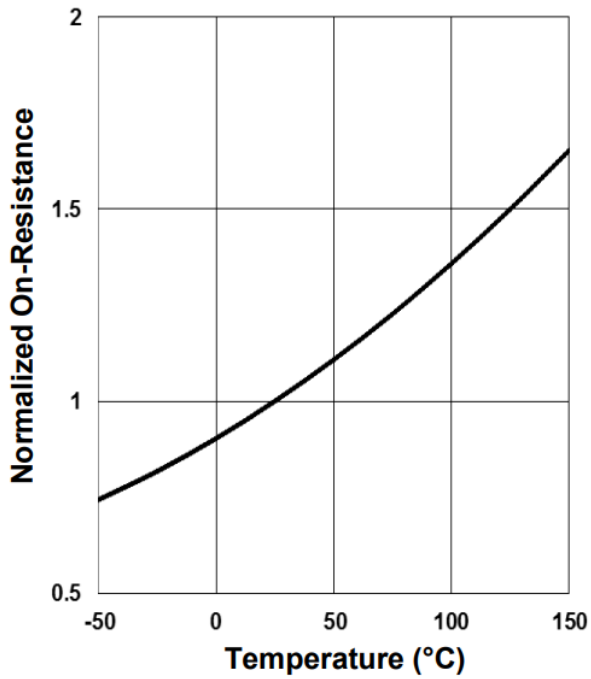

FIG.5 Normalized On-Resistance vs. T_J

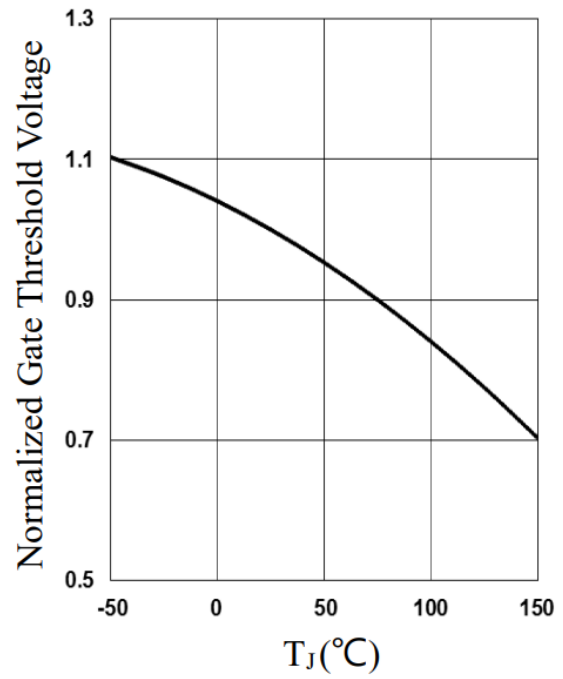

FIG.6 Normalized $V_{GS(th)}$ vs. T_J

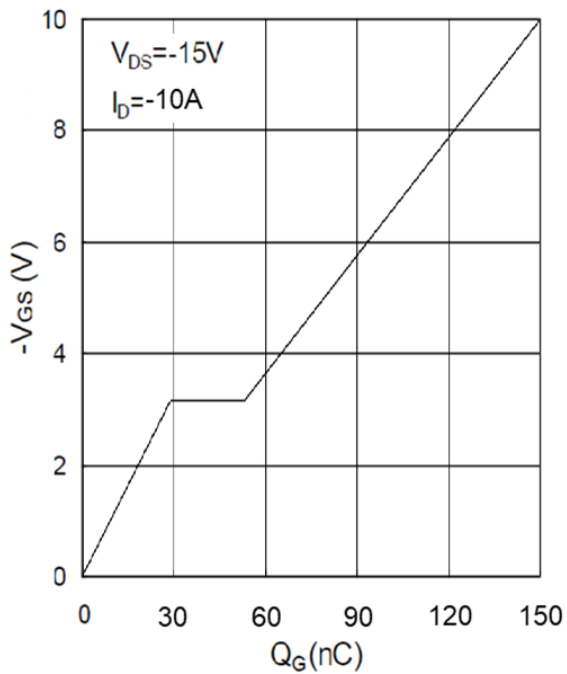

FIG.7 Gate Charge Characteristics

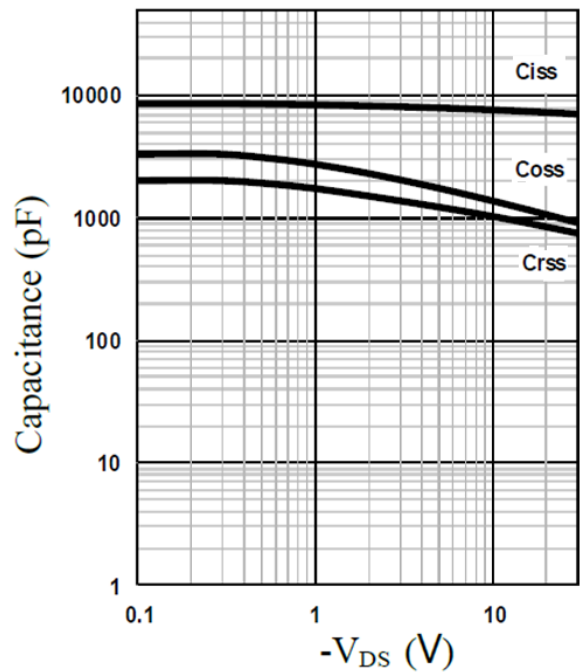

FIG.8 Capacitance Characteristics

Typical Performance Characteristics

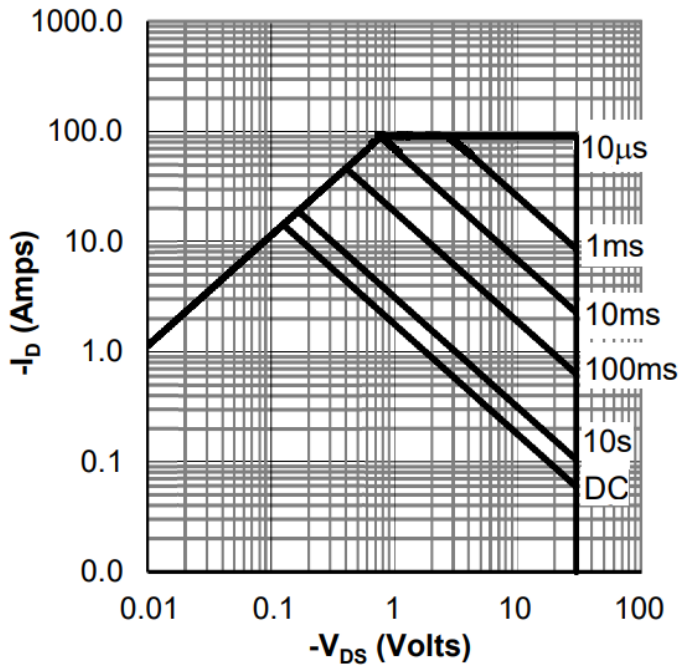

FIG.9 Maximum Safe Operation Area

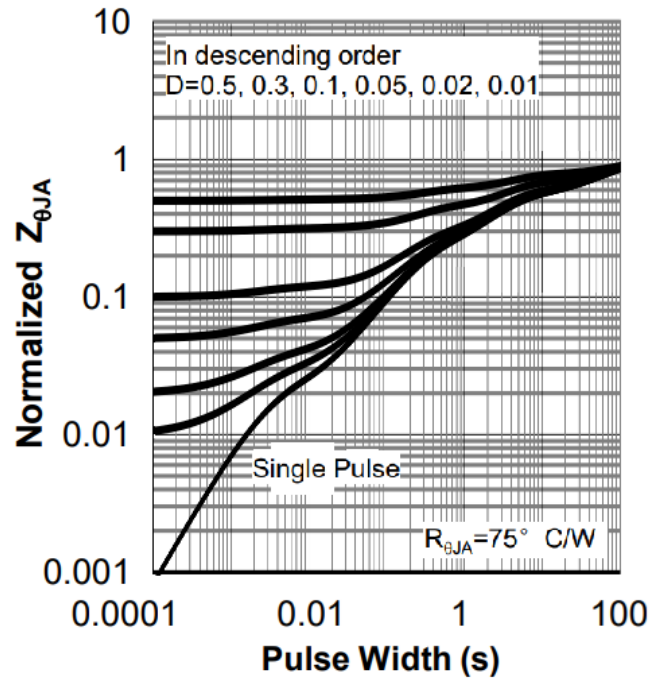
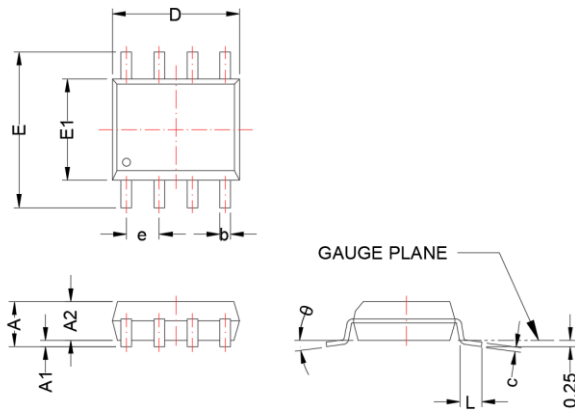

FIG.10 Normalized Transient Impedance

SOP-8L

Package Dimension



Recommended Land Pattern

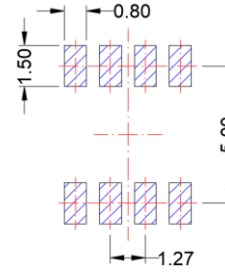

Unit:mm

Dimensions				
Symbol	Millimeters		Inches	
	Min	Max	Min	Max
A	---	1.75	---	0.069
A1	0.10	0.25	0.004	0.010
A2	1.25	---	0.049	---
b	0.31	0.51	0.012	0.020
c	0.10	0.25	0.004	0.010
D	4.70	5.10	0.185	0.201
E	5.80	6.20	0.228	0.244
E1	3.80	4.00	0.150	0.157
e	1.27 BSC		0.050 BSC	
L	0.40	1.27	0.016	0.050
θ	0°	8°	0°	8°





NOTE:



Dimensions are exclusive of Burrs, Mold Flash and Tie Bar extrusions.

NOTICE

- Globaltech Semiconductor assumes no responsibility for equipment failures that result from using products at values that exceed, even momentarily, rated values (such as maximum ratings, operating condition ranges, or other parameters) listed in products specifications of any and all Globaltech Semiconductor products described or contained herein. Globaltech Semiconductor products are not designed for use in life support appliances, devices or systems where malfunction of these products can be reasonably expected to result in personal injury. Reproduction in whole or in part is prohibited without the prior written consent of the copyright owner.
- Applications shown on the herein document are examples of standard use and operation. Customers are responsible in comprehending the suitable use in particular applications. Globaltech Semiconductor makes no representation or warranty that such applications will be suitable for the specified use without further testing or modification.
- Information furnished is believed to be accurate and reliable. However Globaltech Semiconductor assumes no responsibility for the consequences of use of such information nor for any infringement of patents or other rights of third parties, which may result from its use. No license is granted by implication or otherwise under any patent or patent rights of Globaltech Semiconductor. Specifications mentioned in this publication are subject to change without notice. This publication supersedes and replaces all information without express written approval of Globaltech Semiconductor.

CONTACT US

GS Headquarter	
	4F, NO.43-1, Lane 11, Sec. 6, Minquan E. Rd Neihu District, Taipei City 114761, Taiwan (R.O.C).
	886-2-2657-9980
	886-2-2657-3630
	sales_twn@gs-power.com

RD Division	
	824 Bolton Drive Milpitas. CA. 95035
	1-408-457-0587