

# GSM2251ESF

## 25V Dual P-Channel MOSFETs

### Product Description

The P-Channel enhancement mode power field effect transistors are using trench DMOS technology. This advanced technology has been especially tailored to minimize on-state resistance, provide superior switching performance, and withstand high energy pulse in the avalanche and commutation mode.

### Features

- $R_{DS(ON)} = 45m\Omega @ V_{GS} = -10V$
- $R_{DS(ON)} = 65m\Omega @ V_{GS} = -4.5V$
- SOP-8L Package
- RoHS Compliant and Halogen Free

### Applications

- Load Switch
- Battery Protection
- Hand-held Instruments

### Packages & Pin Assignments

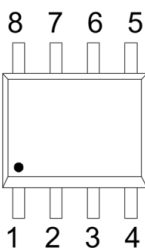
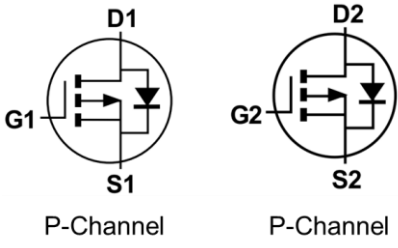
SOP-8L			Equivalent Circuit		
					
Pin	Symbol	Description	Pin	Symbol	Description
1	S1	Source 1	8	D1	Drain 1
2	G1	Gate 1	7	D1	Drain 1
3	S2	Source 2	6	D2	Drain 2
4	G2	Gate 2	5	D2	Drain 2

## Ordering and Marking Information

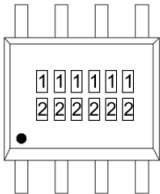
Ordering Information													
Part Number	Package	Part Marking	Quantity / Reel										
GSM2251ESF	SOP-8L	<table border="1"> <tr><td>1</td><td>1</td><td>1</td><td>1</td><td>1</td></tr> <tr><td>2</td><td>2</td><td>2</td><td>2</td><td>2</td></tr> </table>	1	1	1	1	1	2	2	2	2	2	4,000 PCS
1	1	1	1	1									
2	2	2	2	2									
<b>GSM2251E</b> <table border="1"><tr><td>1</td><td>2</td></tr></table>				1	2								
1	2												
<b>- Product Code:</b> GSM2251E		<b>- Package Code:</b> <table border="1"><tr><td>1</td></tr></table> is <b>S</b> for SOP-8L	1	<b>- Green Level:</b> <table border="1"><tr><td>2</td></tr></table> is <b>F</b> for RoHS Compliant and Halogen Free	2								
1													
2													
Marking Information													
		<b>- Product Code:</b> <table border="1"><tr><td>1</td><td>1</td><td>1</td><td>1</td><td>1</td><td>1</td></tr></table> is DS3807 or 2251ES or 3231SF		1	1	1	1	1	1				
1	1	1	1	1	1								
		<b>- GS Code:</b> <table border="1"><tr><td>2</td><td>2</td><td>2</td><td>2</td><td>2</td><td>2</td></tr></table> <ul style="list-style-type: none"> <li>The Dot denotes Pin 1</li> </ul>		2	2	2	2	2	2				
2	2	2	2	2	2								

## Absolute Maximum Ratings (T<sub>J</sub>=25°C Unless otherwise noted)

Symbol	Parameter	Value	Unit
V <sub>DS</sub>	Drain-Source Voltage	-25	V
V <sub>GS</sub>	Gate-Source Voltage	±20	V
I <sub>D</sub>	Continuous Drain Current	T <sub>A</sub> =25°C	-4.6
		T <sub>A</sub> =70°C	-3.7
I <sub>DM</sub>	Pulsed Drain Current <sup>1</sup>	-16	A
P <sub>D</sub>	Power Dissipation	T <sub>A</sub> =25°C	1.47
		T <sub>A</sub> =70°C	0.94
R <sub>θJA</sub>	Thermal Resistance-Junction to Ambient <sup>2</sup>	85	°C/W
T <sub>J</sub>	Operating Junction Temperature Range	-55 to +150	°C
T <sub>STG</sub>	Storage Temperature Range	-55 to +150	°C

**NOTE:**

- Pulsed width is limited by the maximum junction temperature.
- Surface mounted on 1in<sup>2</sup> FR-4 board with 2oz. Copper.

## Electrical Characteristics (T<sub>J</sub>=25°C, unless otherwise specified)

Symbol	Parameter	Test Conditions	Min.	Typ.	Max.	Unit
<b>Static Characteristics</b>						
B <sub>V</sub> DSS	Drain-Source Breakdown Voltage	V <sub>GS</sub> =0V, I <sub>D</sub> =-250μA	-30	-	-	V
I <sub>DSS</sub>	Drain-Source Leakage Current	V <sub>DS</sub> =-20V, V <sub>GS</sub> =0V	-	-	-1	μA
I <sub>GSS</sub>	Gate-Source Leakage Current	V <sub>DS</sub> =0V, V <sub>GS</sub> =±20V	-	-	±30	μA
V <sub>GS(th)</sub>	Gate Threshold Voltage	V <sub>DS</sub> =V <sub>GS</sub> , I <sub>D</sub> =-250μA	-1	-	-2.5	V
R <sub>DS(ON)</sub>	Drain-Source On-Resistance	V <sub>GS</sub> =-10V, I <sub>D</sub> =-4A	-	32	45	mΩ
		V <sub>GS</sub> =-4.5V, I <sub>D</sub> =-3A	-	50	65	
g <sub>fs</sub>	Forward Transconductance	V <sub>DS</sub> =-10V, I <sub>D</sub> =-4A	-	5	-	S
<b>Dynamic Characteristics</b>						
C <sub>iss</sub>	Input Capacitance	V <sub>DS</sub> =-15V, V <sub>GS</sub> =0V, f=1MHz	-	830	-	pF
C <sub>oss</sub>	Output Capacitance		-	100	-	
C <sub>rss</sub>	Reverse Transfer Capacitance		-	75	-	
Q <sub>g</sub>	Total Gate Charge	V <sub>DS</sub> =-15V, I <sub>D</sub> =-4A V <sub>GS</sub> =-10V	-	13.5	-	nC
Q <sub>gs</sub>	Gate-Source Charge		-	2.2	-	
Q <sub>gd</sub>	Gate-Drain Charge		-	2.7	-	
t <sub>d(on)</sub>	Turn-On Delay Time	V <sub>DD</sub> =-15V, I <sub>D</sub> =-1A V <sub>GS</sub> =-10V, R <sub>g</sub> =3.3Ω	-	8	-	ns
t <sub>r</sub>	Turn-On Rise Time		-	5	-	
t <sub>d(off)</sub>	Turn-Off Delay Time		-	22	-	
t <sub>f</sub>	Turn-Off Fall Time		-	5	-	
<b>Diode Characteristics</b>						
V <sub>SD</sub>	Diode Forward Voltage	V <sub>GS</sub> =0V, I <sub>S</sub> =-1A	-	-	-1.2	V

## Typical Performance Characteristics

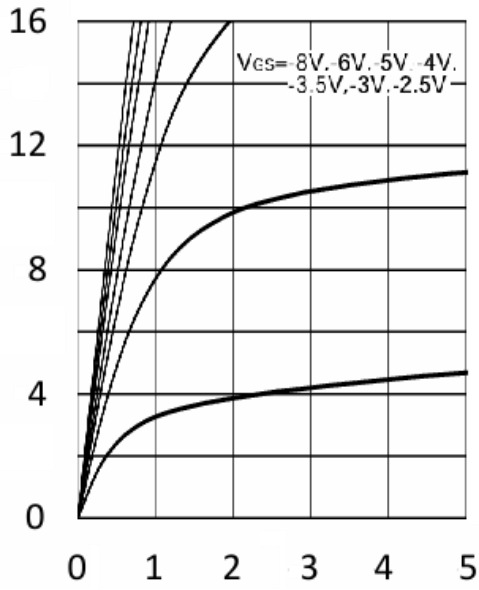

FIG.1 Output Characteristics

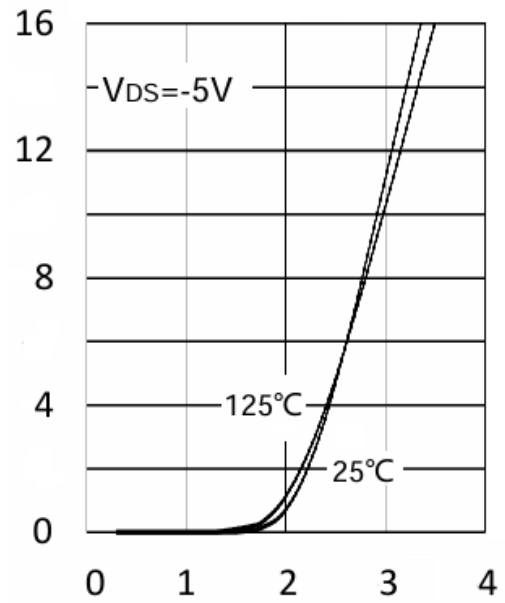

FIG.2 Transfer Characteristics

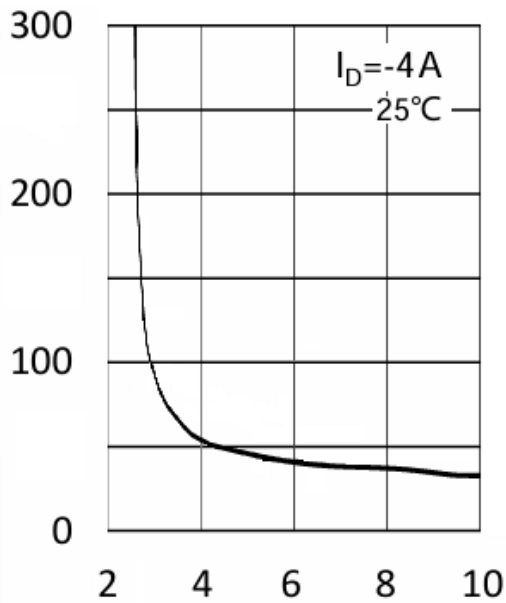

FIG.3 On-Resistance vs. Gate Voltage

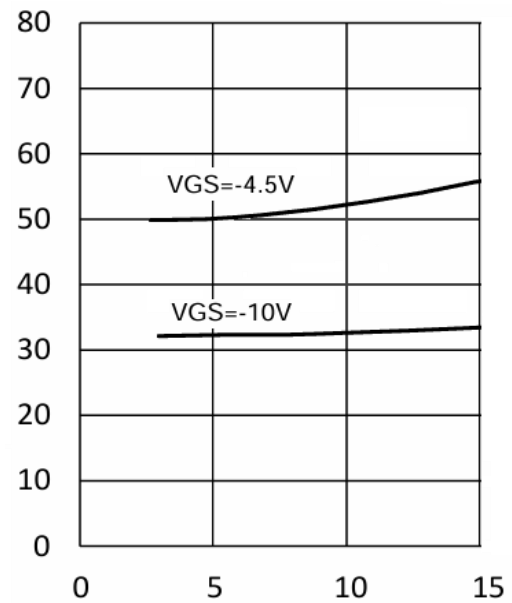

FIG.4 On-Resistance vs. Drain Current

## Typical Performance Characteristics

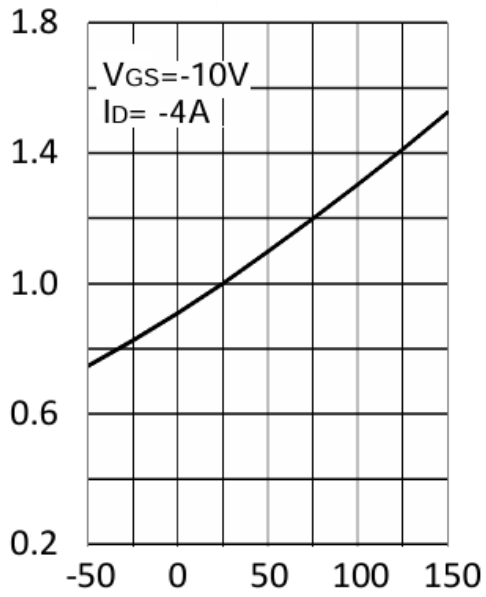

FIG.5 Normalized On-Resistance vs.  $T_J$

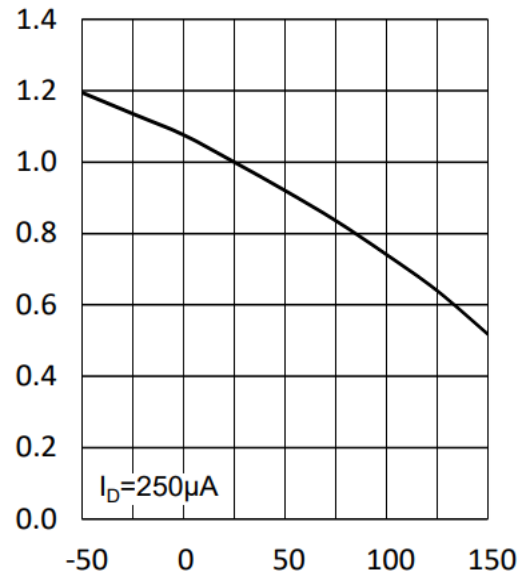

FIG.6 Normalized  $V_{GS(th)}$  vs.  $T_J$

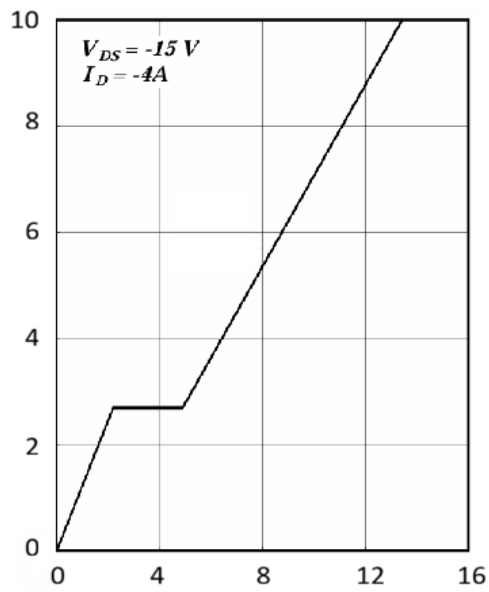

FIG.7 Gate Charge Characteristics

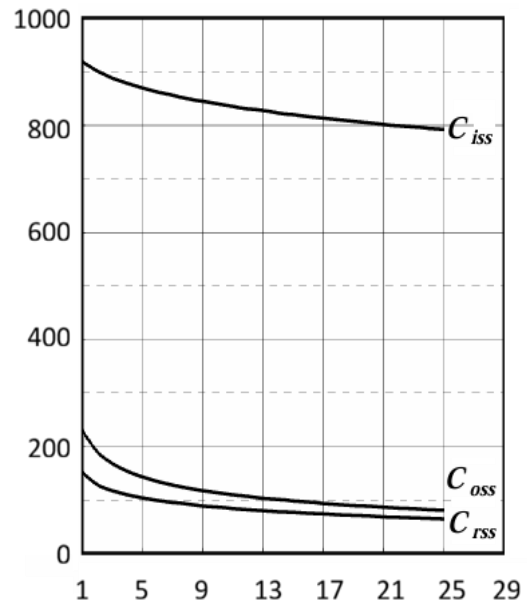

FIG.8 Capacitance Characteristics

## Typical Performance Characteristics

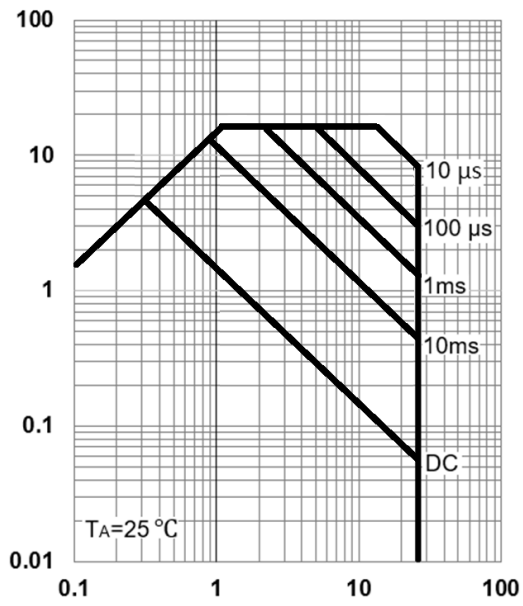

FIG.9 Maximum Safe Operation Area

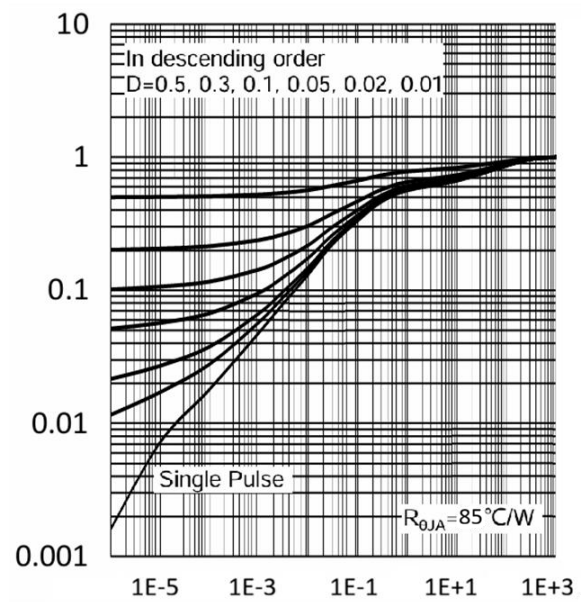
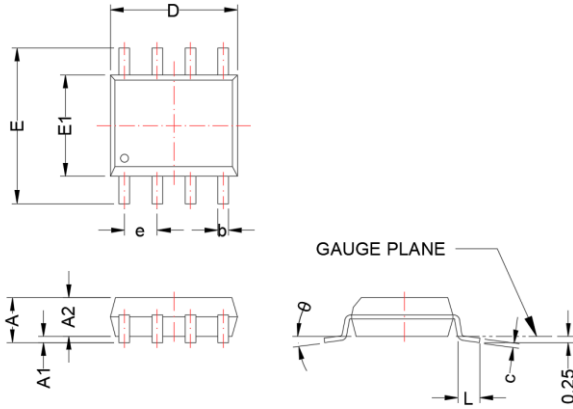

FIG.10 Normalized Transient Impedance

# SOP-8L

## Package Dimension



## Recommended Land Pattern

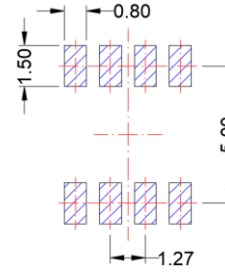

Unit:mm

Dimensions				
Symbol	Millimeters		Inches	
	Min	Max	Min	Max
<b>A</b>	---	1.75	---	0.069
<b>A1</b>	0.10	0.25	0.004	0.010
<b>A2</b>	1.25	---	0.049	---
<b>b</b>	0.31	0.51	0.012	0.020
<b>c</b>	0.10	0.25	0.004	0.010
<b>D</b>	4.70	5.10	0.185	0.201
<b>E</b>	5.80	6.20	0.228	0.244
<b>E1</b>	3.80	4.00	0.150	0.157
<b>e</b>	1.27 BSC		0.050 BSC	
<b>L</b>	0.40	1.27	0.016	0.050
<b>θ</b>	0°	8°	0°	8°





**NOTE:**



Dimensions are exclusive of Burrs, Mold Flash and Tie Bar extrusions.

## NOTICE

- Globaltech Semiconductor assumes no responsibility for equipment failures that result from using products at values that exceed, even momentarily, rated values (such as maximum ratings, operating condition ranges, or other parameters) listed in products specifications of any and all Globaltech Semiconductor products described or contained herein. Globaltech Semiconductor products are not designed for use in life support appliances, devices or systems where malfunction of these products can be reasonably expected to result in personal injury. Reproduction in whole or in part is prohibited without the prior written consent of the copyright owner.
- Applications shown on the herein document are examples of standard use and operation. Customers are responsible in comprehending the suitable use in particular applications. Globaltech Semiconductor makes no representation or warranty that such applications will be suitable for the specified use without further testing or modification.
- Information furnished is believed to be accurate and reliable. However Globaltech Semiconductor assumes no responsibility for the consequences of use of such information nor for any infringement of patents or other rights of third parties, which may result from its use. No license is granted by implication or otherwise under any patent or patent rights of Globaltech Semiconductor. Specifications mentioned in this publication are subject to change without notice. This publication supersedes and replaces all information without express written approval of Globaltech Semiconductor.

## CONTACT US

GS Headquarter	
	4F, NO.43-1, Lane 11, Sec. 6, Minquan E. Rd Neihu District, Taipei City 114761, Taiwan (R.O.C).
	886-2-2657-9980
	886-2-2657-3630
	<a href="mailto:sales_twn@gs-power.com">sales_twn@gs-power.com</a>

RD Division	
	824 Bolton Drive Milpitas. CA. 95035
	1-408-457-0587