

GSMDP4960

40V N-Channel MOSFETs

Product Description

These N-Channel enhancement mode power field effect transistors are using trench DMOS technology. This advanced technology has been especially tailored to minimize on-state resistance, provide superior switching performance, and withstand high energy pulse in the avalanche and commutation mode.

These devices are well suited for high efficiency fast switching applications.

Features

- 40V, 150A, $R_{DS(ON)}=3.8m\Omega@V_{GS}=10V$
- Improved dv/dt capability
- Fast switching
- Green Device Available
- TO-220 package design

Applications

- MB / VGA / Vcore
- POL Applications
- SMPS 2nd SR

Packages & Pin Assignments

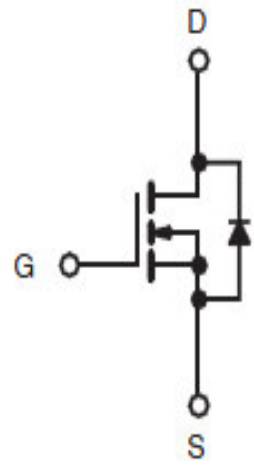
GSMDP4960TF (TO-220)	
 <p>Top View</p>	
	
Pin	Description
1	Gate
2	Drain
3	Source

Ordering Information

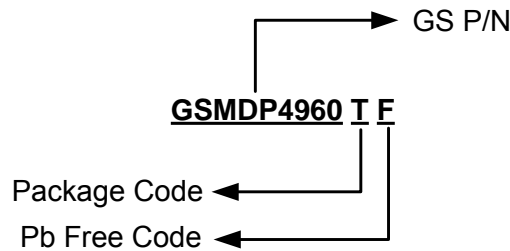

Part Number	Package	Quantity Tube
GSMDP4960TF	TO-220	50 PCS

Marking Information

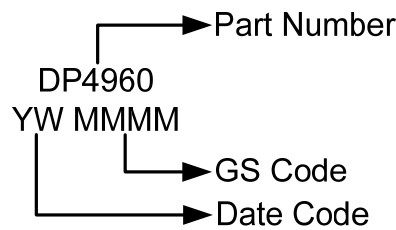

Absolute Maximum Ratings

$T_C=25^\circ\text{C}$ Unless otherwise noted

Symbol	Parameter	Rating	Units
V_{DS}	Drain-Source Voltage	40	V
V_{GS}	Gate-Source Voltage	± 20	V
I_D	Continuous Drain Current	$T_C=25^\circ\text{C}$	150
		$T_C=100^\circ\text{C}$	95
I_{DM}	Pulsed Drain Current (Note 1)	600	A
EAS	Single Pulse Avalanche Energy (Note 2)	312	mJ
IAS	Single Pulse Avalanche Current (Note 2)	79	A
P_D	Power Dissipation ($T_C=25^\circ\text{C}$)	166	W
	Power Dissipation (Derate above 25°C)	1.33	W/ $^\circ\text{C}$
T_J	Operating Junction Temperature Range	-55 to +150	$^\circ\text{C}$
T_{STG}	Storage Temperature Range	-55 to +150	$^\circ\text{C}$
$R_{\theta JA}$	Thermal Resistance-Junction to Ambient	62	$^\circ\text{C}/\text{W}$
$R_{\theta JC}$	Thermal Resistance-Junction to Case	0.75	$^\circ\text{C}/\text{W}$

Note 1: Repetitive Rating: Pulsed width limited by maximum junction temperature.

Note 2: $V_{DD}=25\text{V}$, $V_{GS}=10\text{V}$, $L=0.1\text{mH}$, $I_{AS}=79\text{A}$, Starting $T_J=25^\circ\text{C}$.

Electrical Characteristics

$T_J=25^{\circ}\text{C}$ Unless otherwise noted

Symbol	Parameter	Conditions	Min	Typ	Max	Unit
Static						
$V_{(BR)DSS}$	Drain-Source Breakdown Voltage	$V_{GS}=0V, I_D=250\mu A$	40			V
$\Delta BV_{DSS}/\Delta T_J$	BV_{DSS} Temperature Coefficient	Reference to 25°C , $I_D=1\text{mA}$		0.03		$V/^{\circ}\text{C}$
$V_{GS(th)}$	Gate Threshold Voltage	$V_{DS}=V_{GS}, I_D=250\mu A$	1.2	1.6	2.5	V
$\Delta V_{GS(th)}$	$V_{GS(th)}$ Temperature Coefficient			-5		$\text{mV}/^{\circ}\text{C}$
I_{GSS}	Gate Leakage Current	$V_{DS}=0V, V_{GS}=\pm 20V$			± 100	nA
I_{DSS}	Zero Gate Voltage Drain Current	$V_{DS}=40V, V_{GS}=0V$			1	μA
		$V_{DS}=32V, V_{GS}=0V$, $T_J=125^{\circ}\text{C}$			10	
I_S	Continuous Source Current	$V_G=V_D=0V$, Force Current			150	A
I_{SM}	Pulsed Source Current (Note 3)				300	
$R_{DS(on)}$	Drain-Source On-Resistance (Note 3)	$V_{GS}=10V, I_D=25A$		3.1	3.8	$\text{m}\Omega$
		$V_{GS}=4.5V, I_D=12A$		4.0	5.0	$\text{m}\Omega$
g_{FS}	Forward Transconductance	$V_{DS}=10V, I_D=2A$		16		S
V_{SD}	Diode Forward Voltage (Note 3)	$V_{GS}=0V, I_S=1A$			1	V
Dynamic						
Q_g	Total Gate Charge (Note 3,4)	$V_{DS}=20V, V_{GS}=4.5V$, $I_D=10A$		44.4	80	nC
Q_{gs}	Gate-Source Charge (Note 3,4)			9.6	18	
Q_{gd}	Gate-Drain Charge (Note 3,4)			16	30	
C_{iss}	Input Capacitance	$V_{DS}=25V, V_{GS}=0V$, $f=1\text{MHz}$		4940	7800	pF
C_{oss}	Output Capacitance			425	800	
C_{rss}	Reverse Transfer Capacitance			170	330	
$t_{d(on)}$	Turn-On Time (Note 3,4)	$V_{DD}=20V, I_D=1A$, $V_{GS}=10V, R_G=6\Omega$		28	50	ns
t_r				3.2	6.5	
$t_{d(off)}$	Turn-Off Time (Note 3,4)			89	160	
t_f				14	28	
R_g	Gate Resistance		$V_{DS}=0V, V_{GS}=0V$, $f=1\text{MHz}$		1.4	

Note 3: The data tested by pulsed, pulse width $\leq 300\mu s$, duty cycle $\leq 2\%$.

Note 4: Essentially independent of operating temperature.

Typical Performance Characteristics

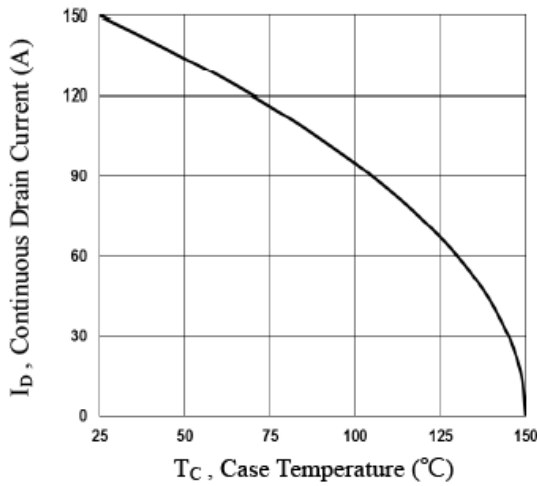

Fig.1 Continuous Drain Current vs. T_C

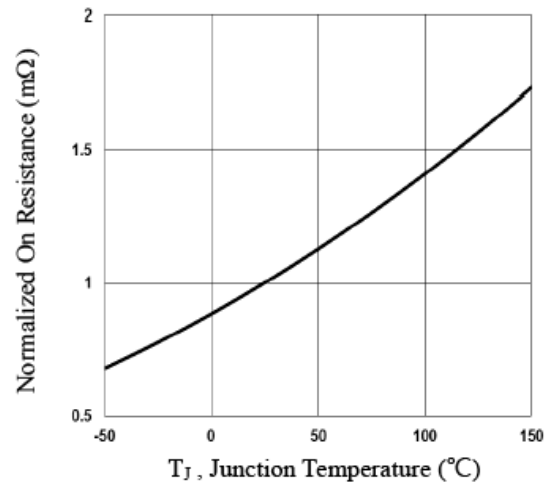

Fig.2 Normalized $R_{DS(on)}$ vs. T_J

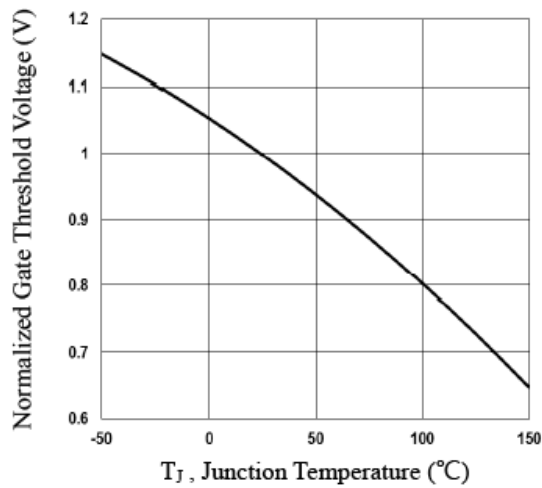

Fig.3 Normalized V_{th} vs. T_J

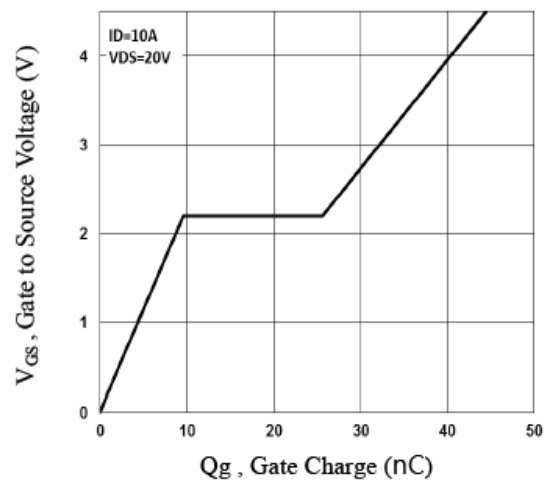

Fig.4 Gate Charge Waveform

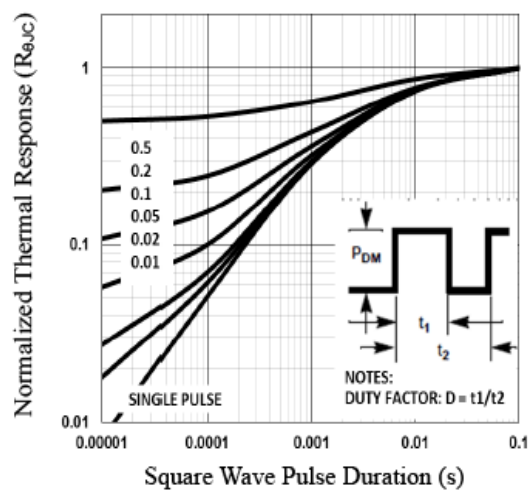

Fig.5 Normalized Transient Impedance

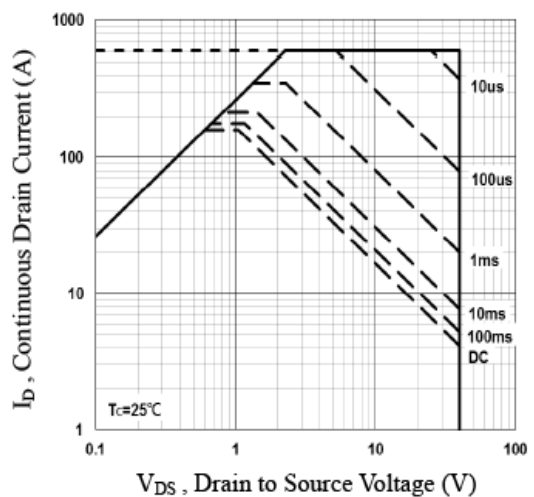
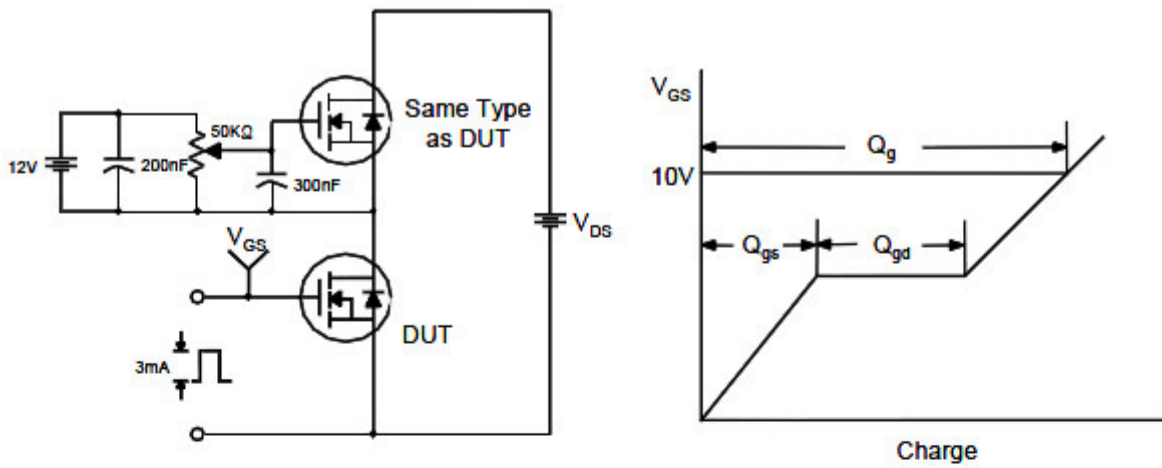

Fig.6 Maximum Safe Operation Area

Typical Performance Characteristics (Continue)

Gate Charge Test Circuit & Waveform



Resistive Switching Test Circuit & Waveforms



Unclamped Inductive Switching Test Circuit & Waveforms



Package Dimension

TO-220

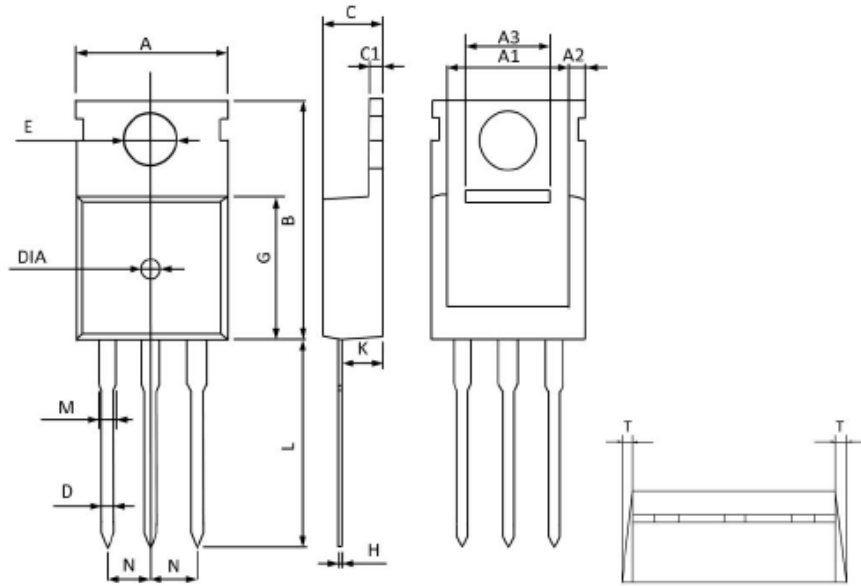







Dimensions				
Symbol	Millimeters		Inches	
	Min	Max	Min	Max
A	9.70	10.30	0.382	0.406
A1	8.44	8.84	0.332	0.348
A2	1.05	1.25	0.041	0.049
A3	5.10	5.30	0.201	0.209
B	15.40	16.20	0.606	0.638
C	4.28	4.68	0.169	0.184
C1	1.10	1.50	0.043	0.059
D	0.60	1.00	0.024	0.039
E	3.40	3.80	0.134	0.150
G	8.70	9.30	0.343	0.366
H	0.40	0.60	0.016	0.024
K	2.10	2.70	0.083	0.106
L	12.80	13.60	0.504	0.535
M	1.10	1.50	0.043	0.059
N	2.49	2.59	0.098	0.102
T	W0.35		W0.014	
DIA	Deep0.2(TYP)	Φ 1.5(TYP)	Deep0.008(TYP)	Φ 0.059(TYP)



NOTICE

Information furnished is believed to be accurate and reliable. However Globaltech Semiconductor assumes no responsibility for the consequences of use of such information nor for any infringement of patents or other rights of third parties, which may result from its use. No license is granted by implication or otherwise under any patent or patent rights of Globaltech Semiconductor. Specifications mentioned in this publication are subject to change without notice. This publication supersedes and replaces all information without express written approval of Globaltech Semiconductor.

CONTACT US

GS Headquarter	
	4F.,No.43-1,Lane11,Sec.6,Minquan E.Rd Neihu District Taipei City 114, Taiwan (R.O.C)
	886-2-2657-9980
	886-2-2657-3630
	sales_twn@gs-power.com

Shenzhen Branch(China)	
	1113 B Building, Happiness Washington, Baoan Nan Road, Luohu District, Shenzhen City, China
	0755-22208941
	sales_cn@gs-power.com

RD Division	
	824 Bolton Drive Milpitas. CA. 95035
	1-408-457-0587