

GSMDC3960X

30V N-Channel MOSFETs

Product Description

These N-Channel enhancement mode power field effect transistors are using trench DMOS technology. This advanced technology has been especially tailored to minimize on-state resistance, provide superior switching performance, and withstand high energy pulse in the avalanche and commutation mode.

These devices are well suited for high efficiency fast switching applications.

Features

- 30V, 115A, $R_{DS(ON)}=2.4m\Omega@V_{GS}=10V$
- Improved dv/dt capability
- Fast switching
- 100% EAS guaranteed
- Green Device Available
- DFN5X6-8L package design

Applications

- MB / VGA / Vcore
- POL Applications
- SMPS 2nd SR

Packages & Pin Assignments

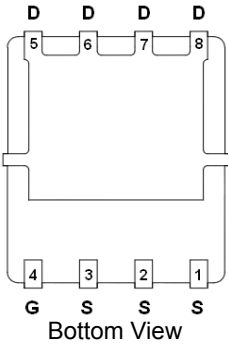
GSMDC3960XFF (DFN5X6-8L)	
 <p>Bottom View</p>	
Pin	Description
1	Source
2	Source
3	Source
4	Gate
5	Drain
6	Drain
7	Drain
8	Drain

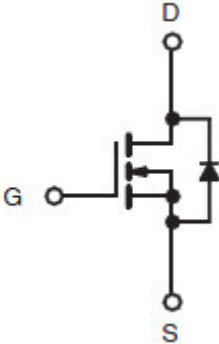

Ordering Information

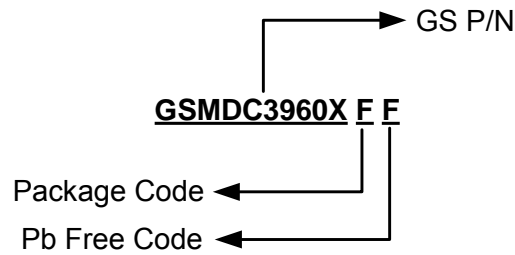

Part Number	Package
GSMDC3960XFF	DFN5X6-8L

Marking Information

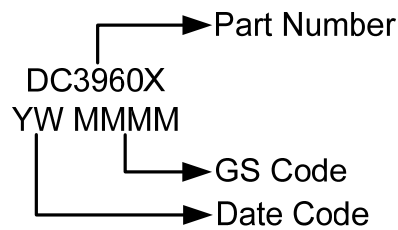

Absolute Maximum Ratings

T_A=25°C Unless otherwise noted

Symbol	Parameter	Typical	Unit
V _{DS}	Drain-Source Voltage	30	V
V _{GS}	Gate –Source Voltage	±20	V
I _D	Continuous Drain Current	T _A =25°C	115
		T _A =100°C	72
I _{DM}	Pulsed Drain Current	460	A
EAS	Single Pulse Avalanche Energy	180	mJ
IAS	Single Pulse Avalanche Current	60	A
P _D	Power Dissipation (T _A =25°C)	135	W
	Power Dissipation (Derate above 25°C)	1.08	W/°C
T _J	Operating Junction Temperature Range	-55 to +150	°C
T _{STG}	Storage Temperature Range	-55 to +150	°C
R _{θJA}	Thermal Resistance-Junction to Ambient	62	°C/W
R _{θJC}	Thermal Resistance-Junction to Case	0.92	°C/W

Electrical Characteristics

T_A=25°C Unless otherwise noted

Symbol	Parameter	Conditions	Min	Typ	Max	Unit
Static						
V _{(BR)DSS}	Drain-Source Breakdown Voltage	V _{GS} =0V, I _D =250uA	30			V
ΔBV _{DSS} /ΔT _J	BV _{DSS} Temperature Coefficient	Reference to 25°C, I _D =1mA		0.03		V/°C
V _{GS(th)}	Gate Threshold Voltage	V _{DS} =V _{GS} , I _D =250uA	1.2	1.6	2.5	V
ΔV _{GS(th)}	V _{GS(th)} Temperature Coefficient			-5		mV/°C
I _{GSS}	Gate Leakage Current	V _{DS} =0V, V _{GS} =±20V			±100	nA
I _{DSS}	Zero Gate Voltage Drain Current	V _{DS} =30V, V _{GS} =0V			1	uA
		V _{DS} =24V, V _{GS} =0V, T _J =125°C			10	
I _S	Continuous Source Current	V _G =V _D =0V, Force Current			176	A
I _{SM}	Pulsed Source Current				352	
R _{DS(on)}	Drain-Source On-Resistance	V _{GS} =10V, I _D =30A		1.9	2.4	mΩ
		V _{GS} =4.5V, I _D =15A		2.5	3.3	
g _{FS}	Forward Transconductance	V _{DS} =10V, I _D =2A		16.5		S
V _{SD}	Diode Forward Voltage	V _{GS} =0V, I _S =1A			1	V
t _{rr}	Reverse Recovery Time	V _{DS} =30V, I _S =1A, di/dt=100A/us		49	85	ns
Q _{rr}	Reverse Recovery Charge			18	35	
Dynamic						
Q _g	Total Gate Charge	V _{DS} =15V, V _{GS} =4.5V, I _D =24A		40	75	nC
Q _{gs}	Gate-Source Charge			6	12	
Q _{gd}	Gate-Drain Charge			19	35	
C _{iss}	Input Capacitance	V _{DS} =25V, V _{GS} =0V, f=1MHz		4800	8000	pF
C _{oss}	Output Capacitance			735	1300	
C _{rss}	Reverse Transfer Capacitance			420	800	
t _{d(on)}	Turn-On Time	V _{DD} =15V, I _D =1A, V _{GS} =10V, R _G =1Ω		20	40	ns
t _r				32	60	
t _{d(off)}	Turn-Off Time			75	130	
t _f				28	55	
R _g	Gate Resistance		V _{DS} =0V, V _{GS} =0V, f=1MHz		1.6	

Typical Performance Characteristics

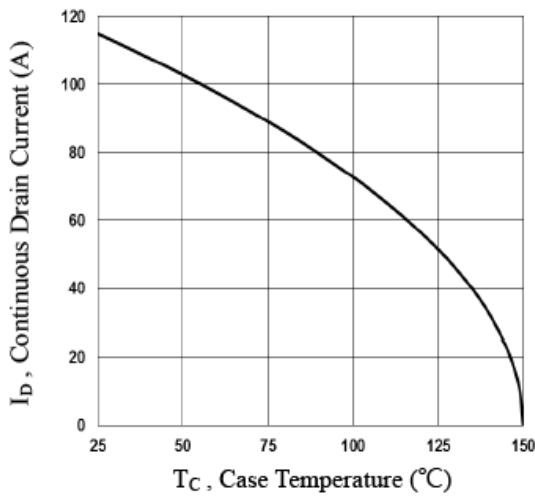

Fig.1 Continuous Drain Current vs. T_c

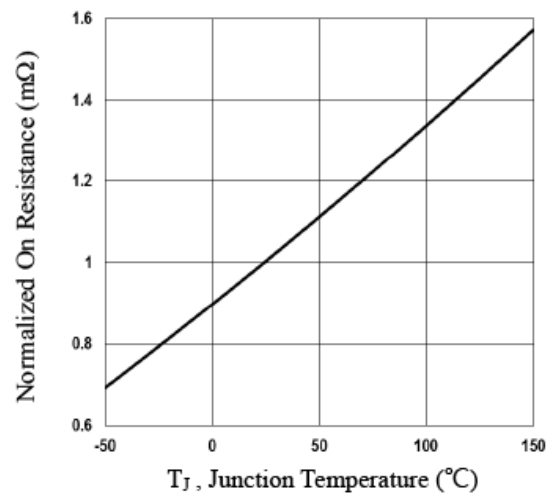

Fig.2 Normalized R_{DSON} vs. T_j

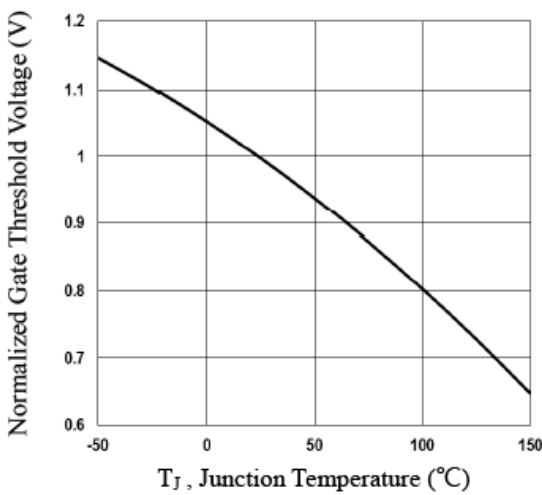

Fig.3 Normalized V_{th} vs. T_j

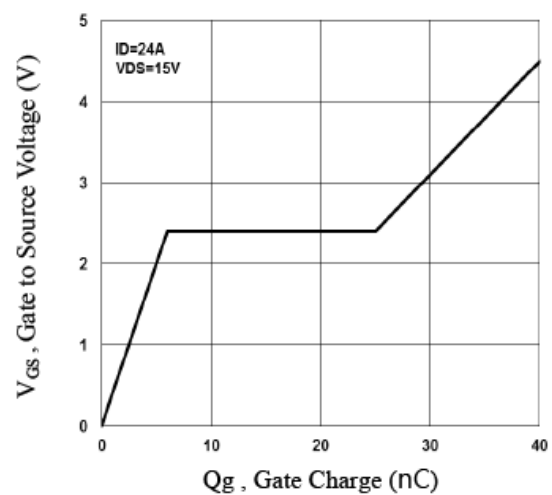

Fig.4 Gate Charge Waveform

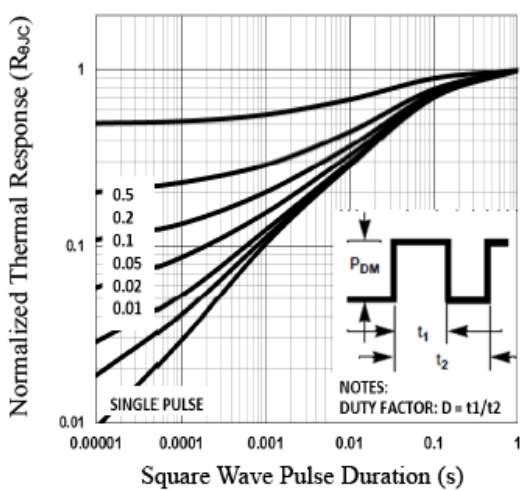

Fig.5 Normalized Transient Impedance

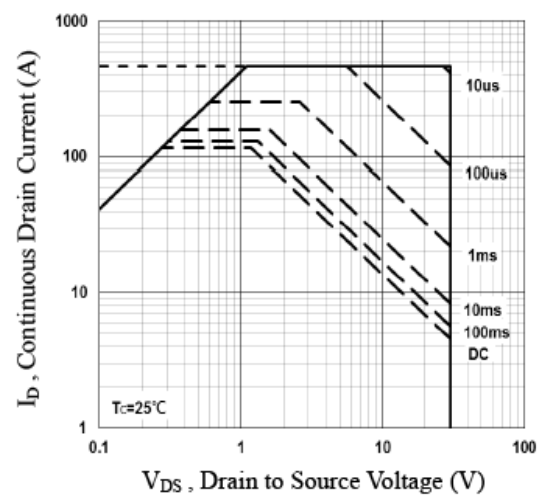
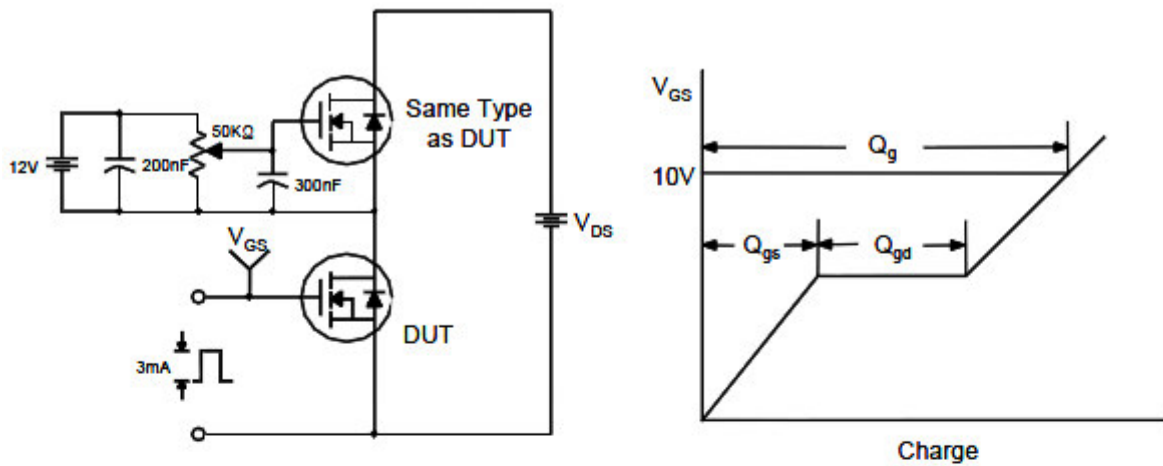

Fig.6 Maximum Safe Operation Area

Typical Performance Characteristics (Continue)

Gate Charge Test Circuit & Waveform



Resistive Switching Test Circuit & Waveforms

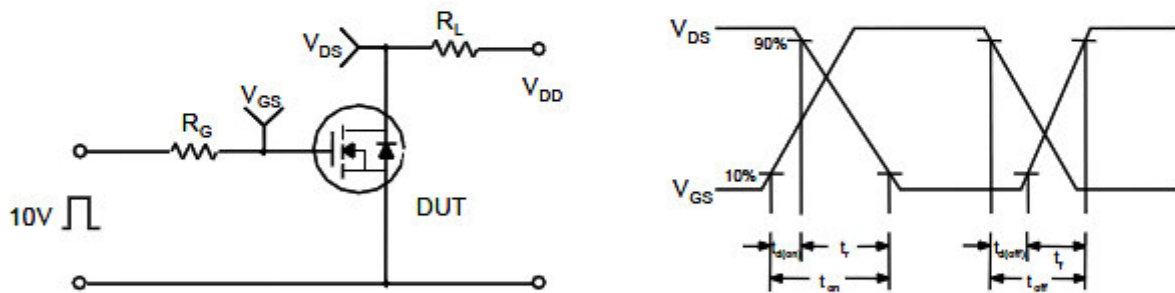

Unclamped Inductive Switching Test Circuit & Waveforms

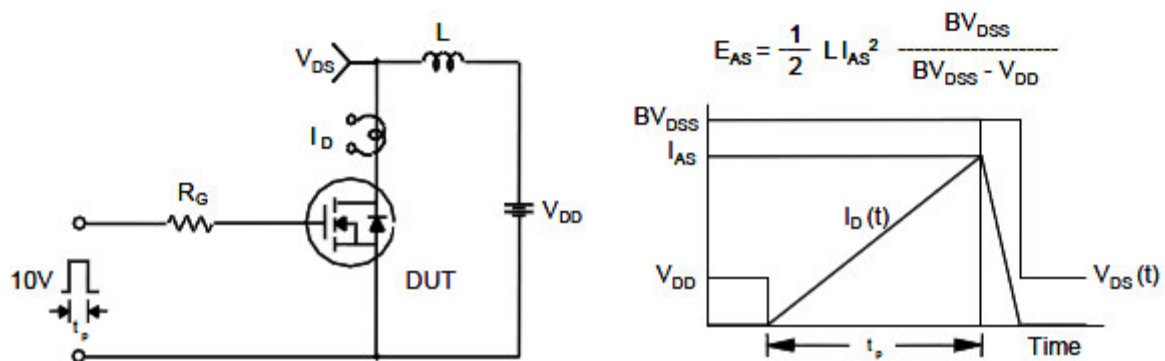

Package Dimension

DFN5X6-8L

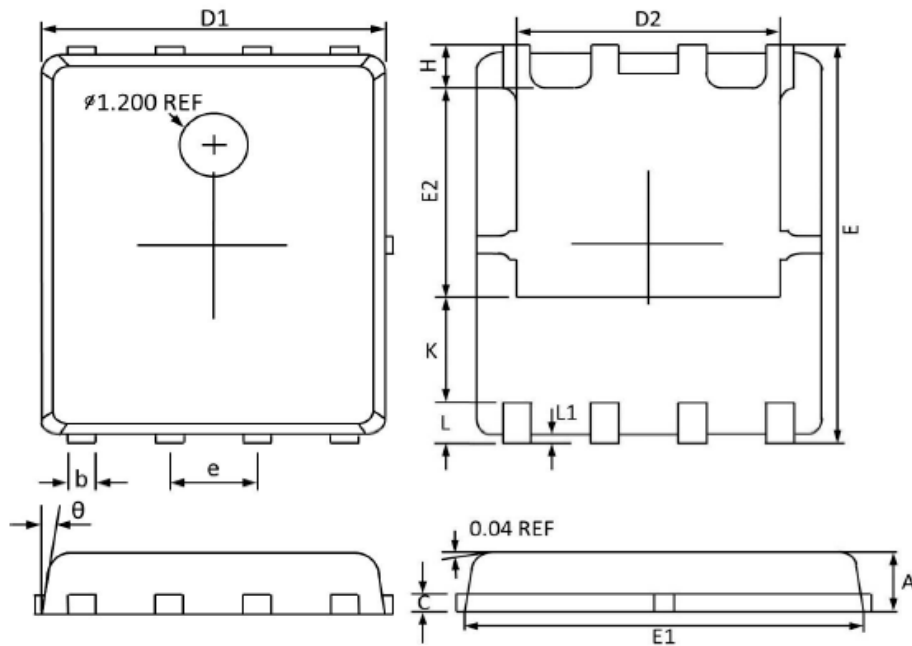

Dimensions				
Symbol	Millimeters		Inches	
	Min	Max	Min	Max
A	0.900	1.100	0.036	0.043
b	0.330	0.510	0.013	0.020
c	0.200	0.300	0.008	0.011
D1	4.800	5.100	0.189	0.201
D2	3.610	4.100	0.142	0.161
E	5.900	6.200	0.232	0.244
E1	5.700	5.900	0.224	0.232
E2	3.350	3.780	0.132	0.149
e	1.270 (BSC)		0.050 (BSC)	
H	0.410	0.700	0.016	0.028
K	1.100	1.500	0.043	0.059
L	0.510	0.710	0.020	0.028
L1	0.060	0.200	0.002	0.008
θ	0°	12°	0°	12°

NOTICE

Information furnished is believed to be accurate and reliable. However Globaltech Semiconductor assumes no responsibility for the consequences of use of such information nor for any infringement of patents or other rights of third parties, which may result from its use. No license is granted by implication or otherwise under any patent or patent rights of Globaltech Semiconductor. Specifications mentioned in this publication are subject to change without notice. This publication supersedes and replaces all information without express written approval of Globaltech Semiconductor.

CONTACT US

GS Headquarter	
	4F.,No.43-1,Lane11,Sec.6,Minquan E.Rd Neihu District Taipei City 114, Taiwan (R.O.C)
	886-2-2657-9980
	886-2-2657-3630
	sales_twn@gs-power.com

Shenzhen Branch(China)	
	1113 B Building, Happiness Washington, Baoan Nan Road, Luohu District, Shenzhen City, China
	0755-22208941
	sales_cn@gs-power.com

RD Division	
	824 Bolton Drive Milpitas. CA. 95035
	1-408-457-0587