

GSM3025S

30V N-Channel Enhancement Mode MOSFET

Product Description

GSM3025S, N-Channel enhancement mode MOSFET, uses Advanced Trench Technology to provide excellent $R_{DS(ON)}$, low gate charge.

These devices are particularly suited for low voltage power management, and low in-line power loss are needed in commercial industrial surface mount applications.

Features

- 30V/9.0A, $R_{DS(ON)}=32m\Omega@V_{GS}=10V$
- 30V/7.0A, $R_{DS(ON)}=36m\Omega@V_{GS}=4.5V$
- 30V/5.0A, $R_{DS(ON)}=42m\Omega@V_{GS}=2.5V$
- Super high density cell design for extremely low $R_{DS(ON)}$
- TO-252-2L package design

Applications

- DC/DC Converter
- Load Switch / CCFL Inverter
- Power Management in Notebook Computer

Packages & Pin Assignments

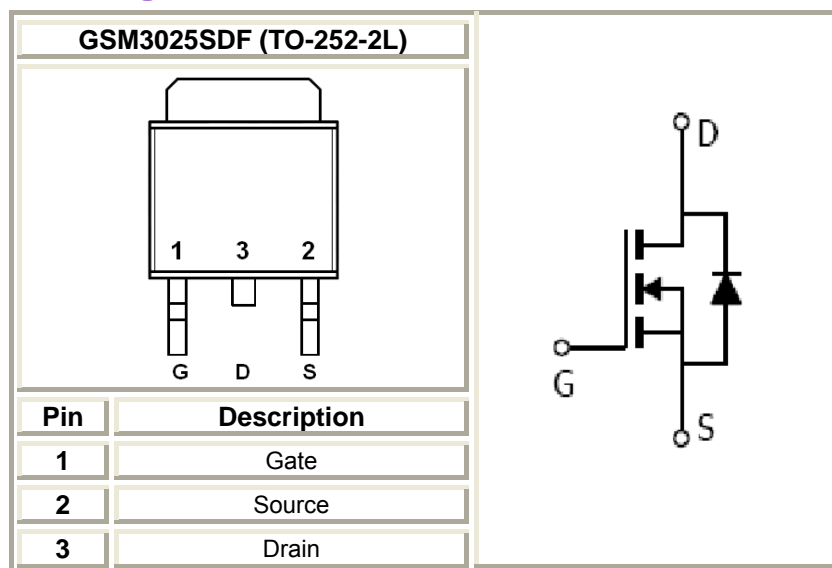

Ordering & Marking Information

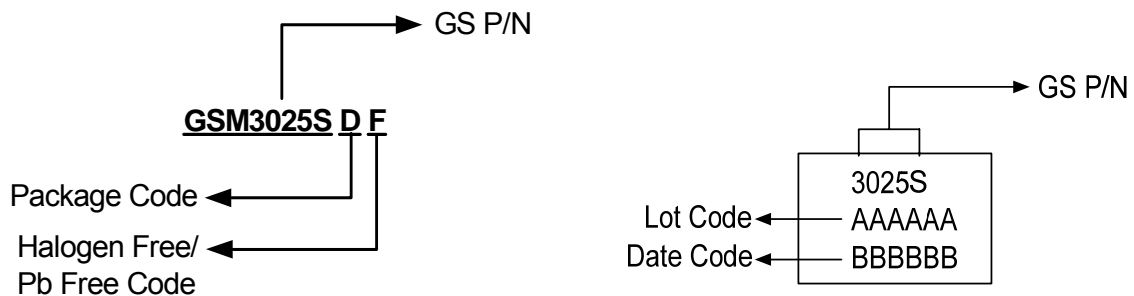

Part Ordering No.	Part Marking	Package	Quantity Reel
GSM3025SDF	3025S	TO-252-2L	2500 PCS

Absolute Maximum Ratings

($T_A=25^\circ\text{C}$ unless otherwise noted)

Symbol	Parameter	Typical	Unit	
V_{DSS}	Drain-Source Voltage	30	V	
V_{GSS}	Gate-Source Voltage	± 12	V	
I_D	Continuous Drain Current($T_J=150^\circ\text{C}$)	$T_A=25^\circ\text{C}$	22	A
		$T_A=70^\circ\text{C}$	16	
I_{DM}	Pulsed Drain Current	45	A	
I_S	Continuous Source Current(Diode Conduction)	9.0	A	
P_D	Power Dissipation	$T_A=25^\circ\text{C}$	40	W
		$T_A=70^\circ\text{C}$	15	
T_J	Operating Junction Temperature	150	$^\circ\text{C}$	
T_{STG}	Storage Temperature Range	-55/150	$^\circ\text{C}$	
$R_{\theta JA}$	Thermal Resistance-Junction to Ambient	62.5	$^\circ\text{C}/\text{W}$	

Electrical Characteristics

($T_A=25^\circ\text{C}$ unless otherwise noted)

Symbol	Parameter	Conditions	Min	Typ	Max	Unit
Static						
$V_{(BR)DSS}$	Drain-Source Breakdown Voltage	$V_{GS}=0V, I_D=250\mu\text{A}$	30			V
$V_{GS(th)}$	Gate Threshold Voltage	$V_{DS}=V_{GS}, I_D=250\mu\text{A}$	0.6		1.1	
I_{GSS}	Gate Leakage Current	$V_{DS}=0V, V_{GS}=\pm 16V$			± 100	nA
I_{DSS}	Zero Gate Voltage Drain Current	$V_{DS}=24V, V_{GS}=0V$			1	uA
		$V_{DS}=24V, V_{GS}=0V, T_J=85^\circ\text{C}$			30	
$I_{D(on)}$	On-State Drain Current	$V_{DS} \geq 5V, V_{GS}=4.5V$	15			A
$R_{DS(on)}$	Drain-Source On-Resistance	$V_{GS}=10V, I_D=9.0A$		24	32	m Ω
		$V_{GS}=4.5V, I_D=7.0A$		26	36	
		$V_{GS}=2.5V, I_D=5.0A$		32	42	
g_{fs}	Forward Transconductance	$V_{DS}=10V, I_D=6.1A$		20		S
V_{SD}	Diode Forward Voltage	$I_S=1.7A, V_{GS}=0V$		0.8	1.2	V
Dynamic						
C_{iss}	Input Capacitance	$V_{DS}=15V, V_{GS}=0V, f=1\text{MHz}$		320		pF
C_{oss}	Output Capacitance			70		
C_{rss}	Reverse Transfer Capacitance			30		
Q_g	Total Gate Charge	$V_{DS}=15V, V_{GS}=10V, I_D=2.6A$		3.0	4.5	nC
Q_{gs}	Gate-Source Charge			1.6		
Q_{gd}	Gate-Drain Charge			0.6		
$t_{d(on)}$	Turn-On Time	$V_{DD}=15V, R_L=15\Omega, I_D=1.0A, V_{GEN}=10V, R_G=6\Omega$		8	12	ns
t_r				12	18	
$t_{d(off)}$	Turn-Off Time			15	30	
t_f				8	15	

Typical Performance Characteristics

Output Characteristics

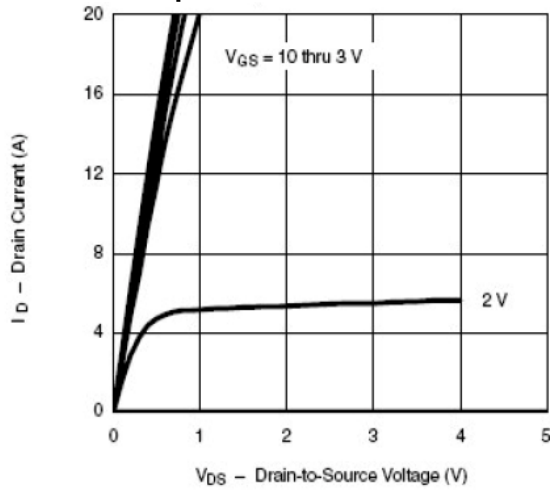

Transfer Characteristics

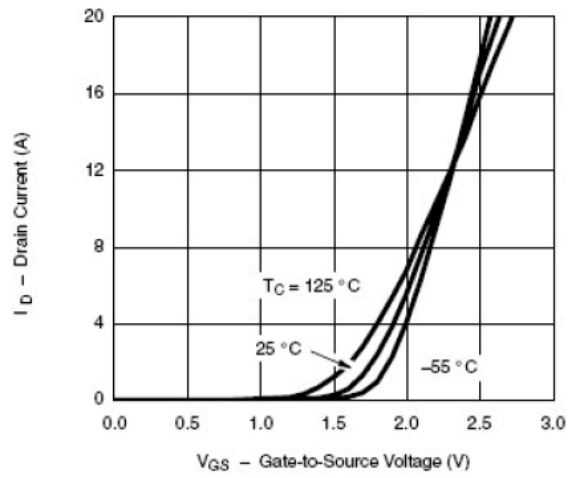

On-Resistance vs. Drain Current

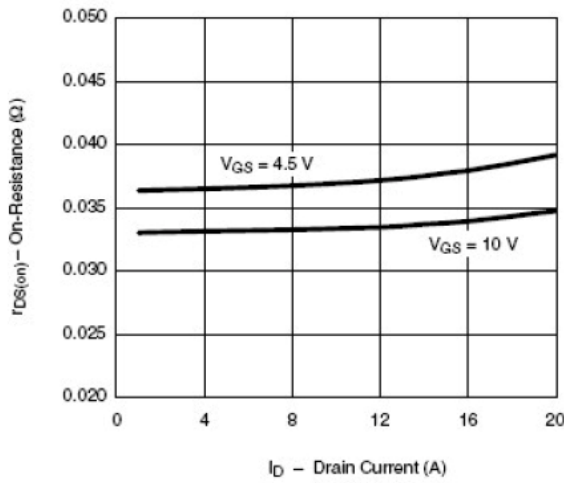

Capacitance

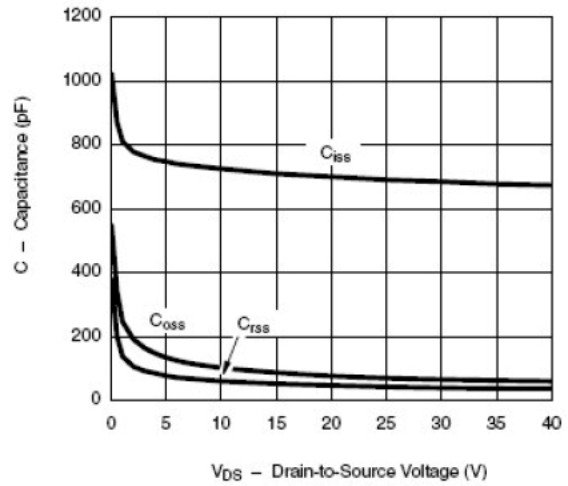

Gate Charge

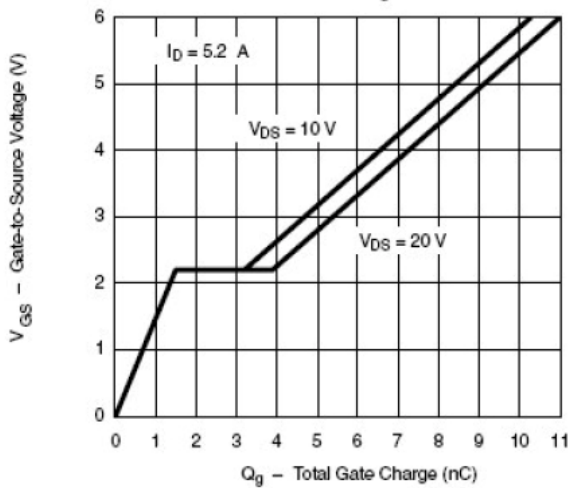

On-Resistance vs. Junction Temperature

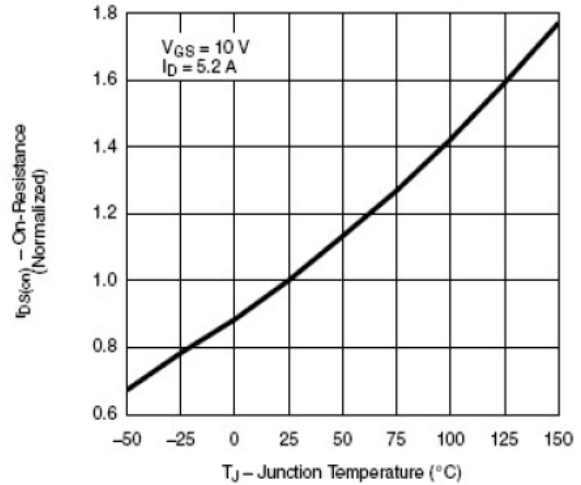

Typical Performance Characteristics (continue)

Source-Drain Diode Forward Voltage

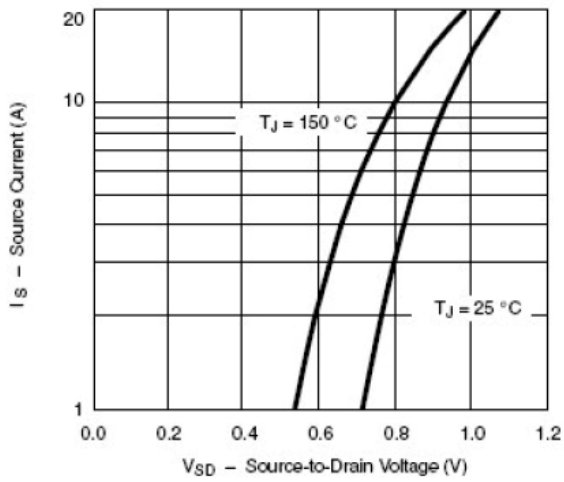

On-Resistance vs. Gate-to-Source Voltage

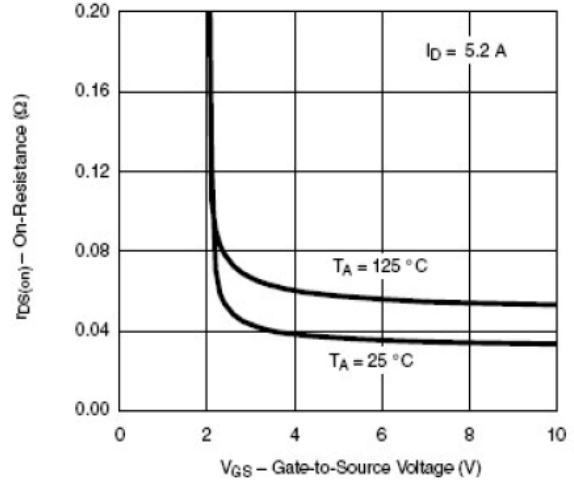

Threshold Voltage

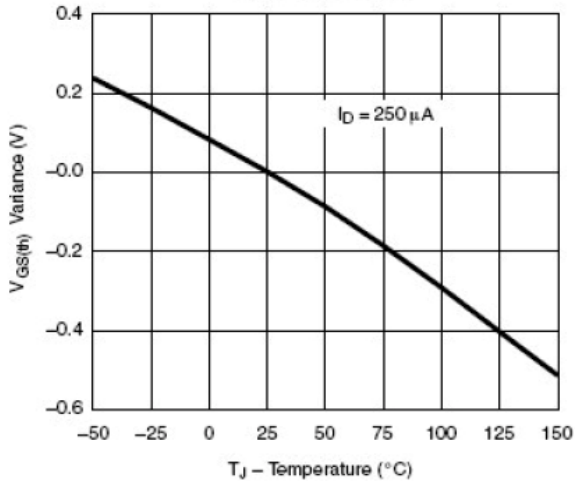

Single Pulse Power, Junction-to-Ambient

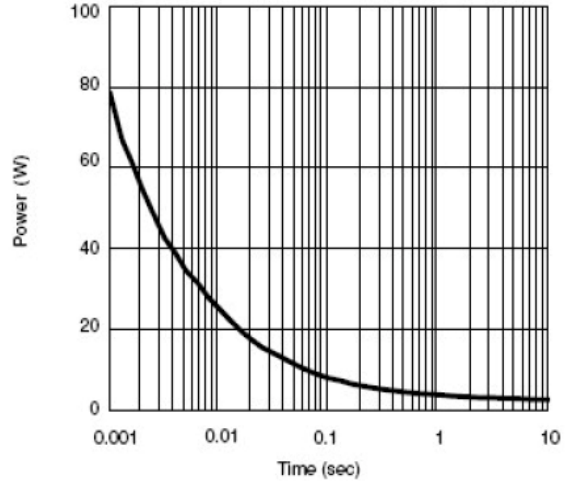

Normalized Thermal Transient Impedance, Junction-to-Foot

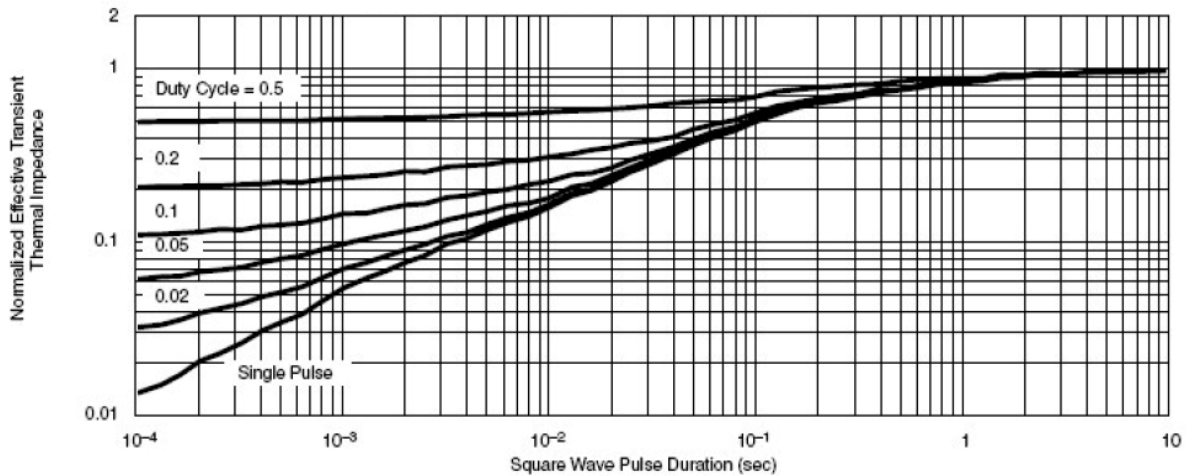

Typical Characteristics

Gate Charge Test Circuit & Waveform

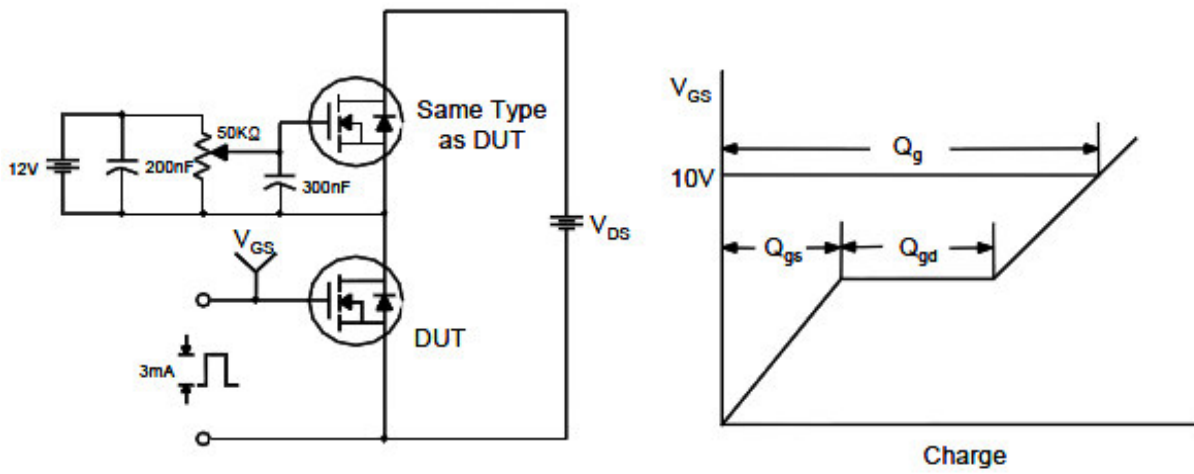

Resistive Switching Test Circuit & Waveforms

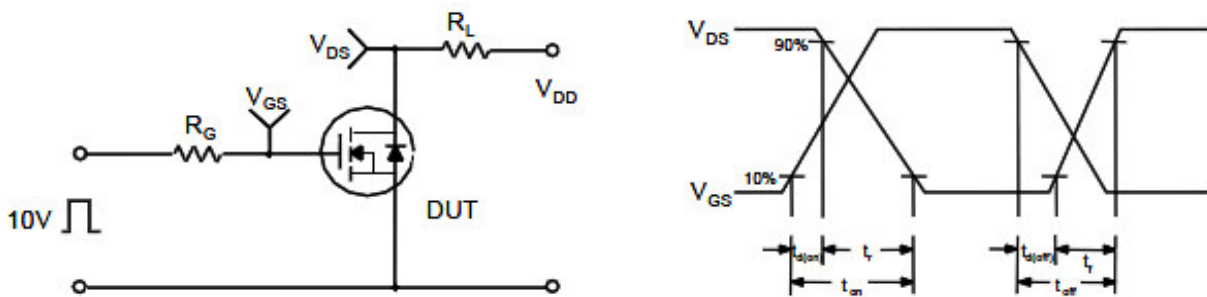

Unclamped Inductive Switching Test Circuit & Waveforms

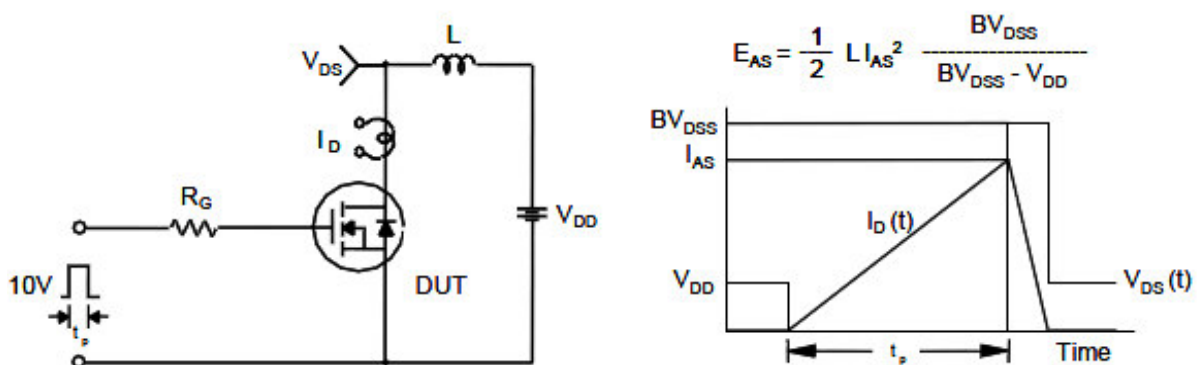

Package Dimension

TO-252-2L PLASTIC PACKAGE

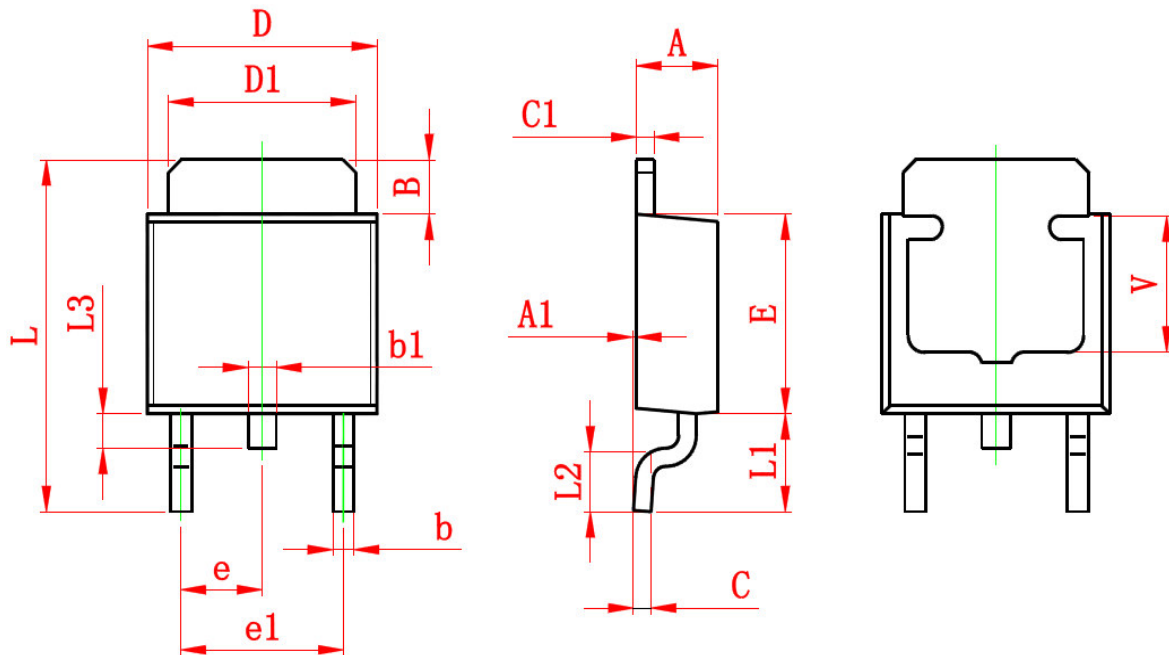





Dimensions



SYMBOL	Millimeters		Inches	
	MIN	MAX	MIN	MAX
A	2.200	2.400	0.087	0.094
A1	0.000	0.127	0.000	0.005
B	1.350	1.650	0.053	0.065
b	0.500	0.700	0.020	0.028
b1	0.700	0.900	0.028	0.035
c	0.430	0.580	0.017	0.023
c1	0.430	0.580	0.017	0.023
D	6.350	6.650	0.250	0.262
D1	5.200	5.400	0.205	0.213
E	5.400	5.700	0.213	0.224
e	2.300 TYP		0.091 TYP	
e1	4.500	4.700	0.177	0.185
L	9.500	9.900	0.374	0.390
L1	2.550	2.900	0.100	0.114
L2	1.400	1.780	0.055	0.070
L3	0.600	0.900	0.024	0.035
V	3.800 REF		0.150 REF	



NOTICE

Information furnished is believed to be accurate and reliable. However Globaltech Semiconductor assumes no responsibility for the consequences of use of such information nor for any infringement of patents or other rights of third parties, which may result from its use. No license is granted by implication or otherwise under any patent or patent rights of Globaltech Semiconductor. Specifications mentioned in this publication are subject to change without notice. This publication supersedes and replaces all information without express written approval of Globaltech Semiconductor.

CONTACT US

GS Headquarter	
	4F.,No.43-1,Lane11,Sec.6,Minquan E.Rd Neihu District Taipei City 114, Taiwan (R.O.C)
	886-2-2657-9980
	886-2-2657-3630
	sales_twn@gs-power.com

Shenzhen Branch(China)	
	1113 B Building, Happiness Washington, Baoan Nan Road, Luohu District, Shenzhen City, China
	0755-22208941
	sales_cn@gs-power.com

RD Division	
	824 Bolton Drive Milpitas. CA. 95035
	1-408-457-0587