

# GSM1012

## 20V N-Channel Enhancement Mode MOSFET

### Product Description

GSM1012, N-Channel enhancement mode MOSFET, uses Advanced Trench Technology to provide excellent  $R_{DS(ON)}$ , low gate charge.

These devices are particularly suited for low voltage power management, such as smart phone and notebook computer, and low in-line power loss are needed in commercial industrial surface mount applications.

### Features

- 20V/0.6A,  $R_{DS(ON)}=360m@V_{GS}=4.5V$
- 20V/0.5A,  $R_{DS(ON)}=420m@V_{GS}=2.5V$
- 20V/0.4A,  $R_{DS(ON)}=560m@V_{GS}=1.8V$
- Low Offset (Error) Voltage
- Low-Voltage Operation
- High-Speed Circuits
- Low Battery Voltage Operation
- SOT-523 package design

### Applications

- Drivers: Relays, Solenoids, Lamps, Hammers, Displays, Memories
- Battery Operated Systems
- Power Supply Converter Circuits
- Load/Power Switching Smart Phones, Pagers

### Packages & Pin Assignments

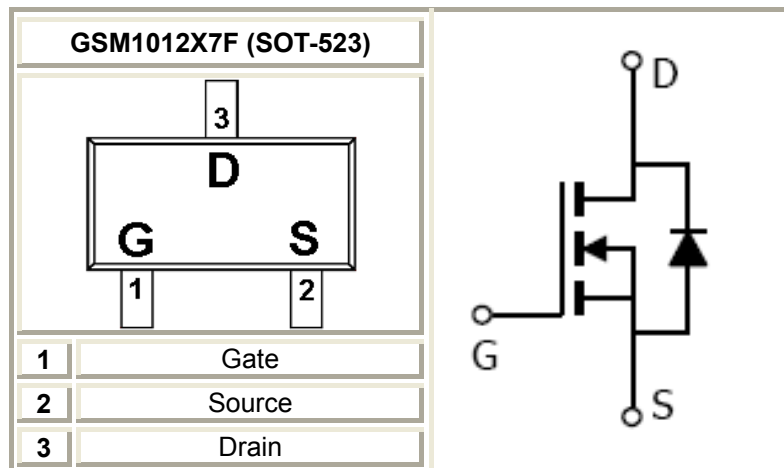

## Ordering Information

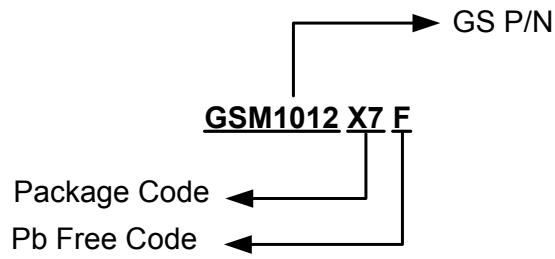

Part Number	Package	Quantity Reel
GSM1012X7F	SOT-523	3000 PCS

## Marking Information

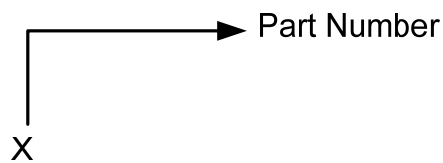

## Absolute Maximum Ratings

(T<sub>A</sub>=25°C Unless otherwise noted)

Symbol	Parameter	Typical	Unit	
V <sub>DSS</sub>	Drain-Source Voltage	20	V	
V <sub>GSS</sub>	Gate –Source Voltage	±12	V	
I <sub>D</sub>	Continuous Drain Current(T <sub>J</sub> =150°C)	T <sub>A</sub> =25°C	0.7	A
		T <sub>A</sub> =70°C	0.4	
I <sub>DM</sub>	Pulsed Drain Current	1.0	A	
I <sub>S</sub>	Continuous Source Current(Diode Conduction)	0.3	A	
P <sub>D</sub>	Power Dissipation	T <sub>A</sub> =25°C	0.27	W
		T <sub>A</sub> =70°C	0.16	
T <sub>J</sub>	Operating Junction Temperature	-55/150	°C	
T <sub>STG</sub>	Storage Temperature Range	-55/150	°C	

## Electrical Characteristics

(T<sub>A</sub>=25°C Unless otherwise noted)

Symbol	Parameter	Conditions	Min	Typ	Max	Unit
<b>Static</b>						
V <sub>(BR)DSS</sub>	Drain-Source Breakdown Voltage	V <sub>GS</sub> =0V, I <sub>D</sub> =250uA	20			V
V <sub>GS(th)</sub>	Gate Threshold Voltage	V <sub>DS</sub> =V <sub>GS</sub> , I <sub>D</sub> =250uA	0.4		1.0	
I <sub>GSS</sub>	Gate Leakage Current	V <sub>DS</sub> =0V, V <sub>GS</sub> =±12V			±100	nA
I <sub>DSS</sub>	Zero Gate Voltage Drain Current	V <sub>DS</sub> = 20V, V <sub>GS</sub> =0V			1	uA
		V <sub>DS</sub> = 20V, V <sub>GS</sub> =0V, T <sub>J</sub> =85°C			5	
I <sub>D(on)</sub>	On-State Drain Current	V <sub>DS</sub> ≥5V, V <sub>GS</sub> =4.5V	0.7			A
R <sub>DS(on)</sub>	Drain-Source On-Resistance	V <sub>GS</sub> =4.5V, I <sub>D</sub> =0.6A		240	360	mΩ
		V <sub>GS</sub> =2.5V, I <sub>D</sub> =0.5A		300	420	
		V <sub>GS</sub> =1.8V, I <sub>D</sub> =0.4A		420	560	
g <sub>fs</sub>	Forward Transconductance	V <sub>DS</sub> =10V, I <sub>D</sub> =0.4A		1.0		S
V <sub>SD</sub>	Diode Forward Voltage	I <sub>S</sub> =0.15A, V <sub>GS</sub> =0V		0.65	1.2	V
<b>Dynamic</b>						
C <sub>iss</sub>	Input Capacitance	V <sub>DS</sub> =10V, V <sub>GS</sub> =0V, f=1MHz		70		pF
C <sub>oss</sub>	Output Capacitance			20		
C <sub>rss</sub>	Reverse Transfer Capacitance			8		
Q <sub>g</sub>	Total Gate Charge	V <sub>DS</sub> =10V, V <sub>GS</sub> =4.5V, I <sub>D</sub> =0.6A		1.06	1.38	nC
Q <sub>gs</sub>	Gate-Source Charge			0.18		
Q <sub>gd</sub>	Gate-Drain Charge			0.32		
t <sub>d(on)</sub>	Turn-On Time	V <sub>DD</sub> =10V, R <sub>L</sub> =20Ω, I <sub>D</sub> =0.5A, V <sub>GEN</sub> =4.5V, R <sub>G</sub> =1Ω		18	26	ns
t <sub>r</sub>				20	28	
t <sub>d(off)</sub>	Turn-Off Time			70	110	
t <sub>f</sub>				25	40	

## Typical Performance Characteristics

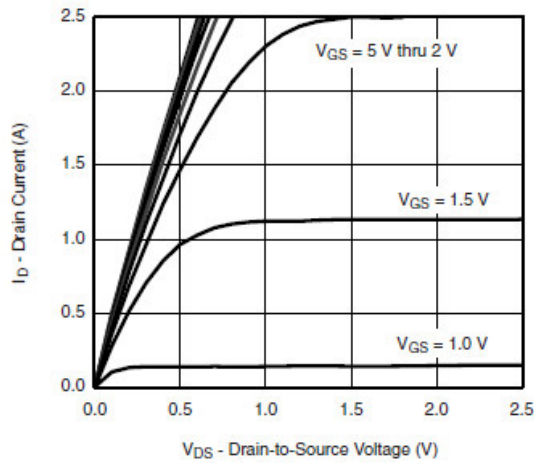

Output Characteristics

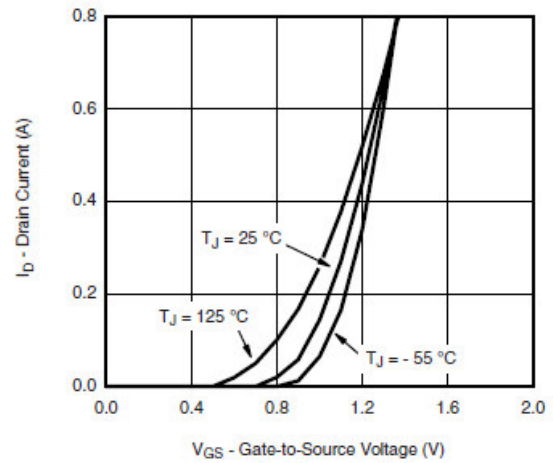

Transfer Characteristics

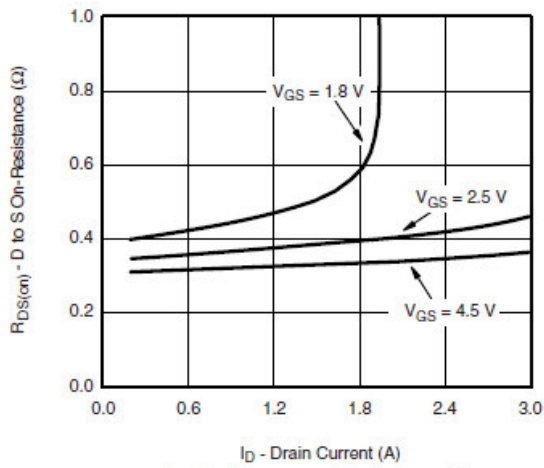

On-Resistance vs. Drain Current

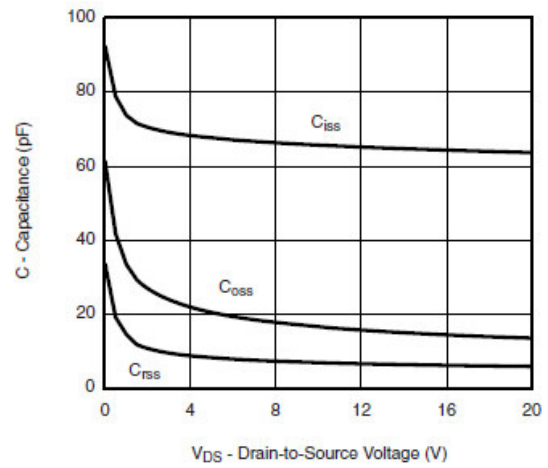

Capacitance

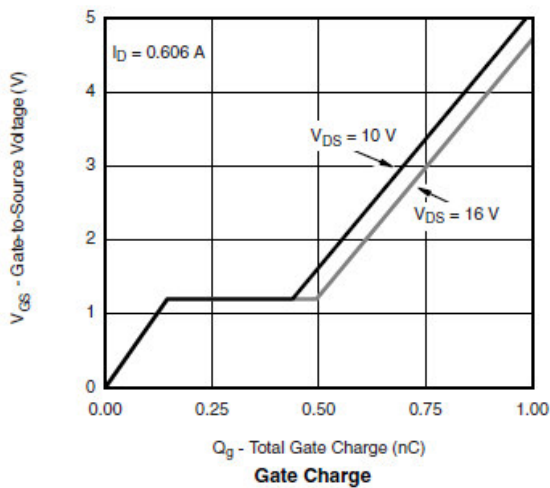

Gate Charge

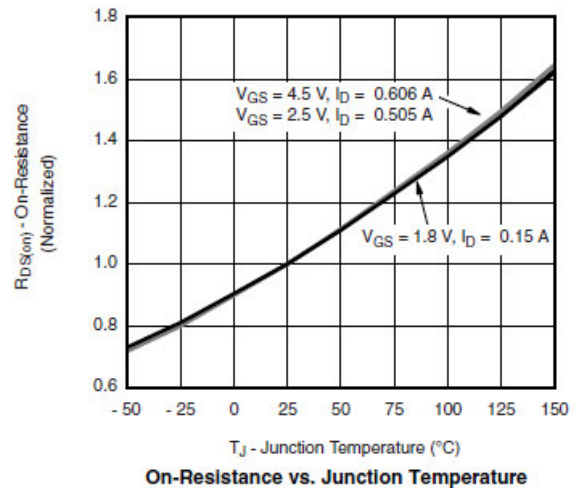

On-Resistance vs. Junction Temperature

## Typical Performance Characteristics(continue)

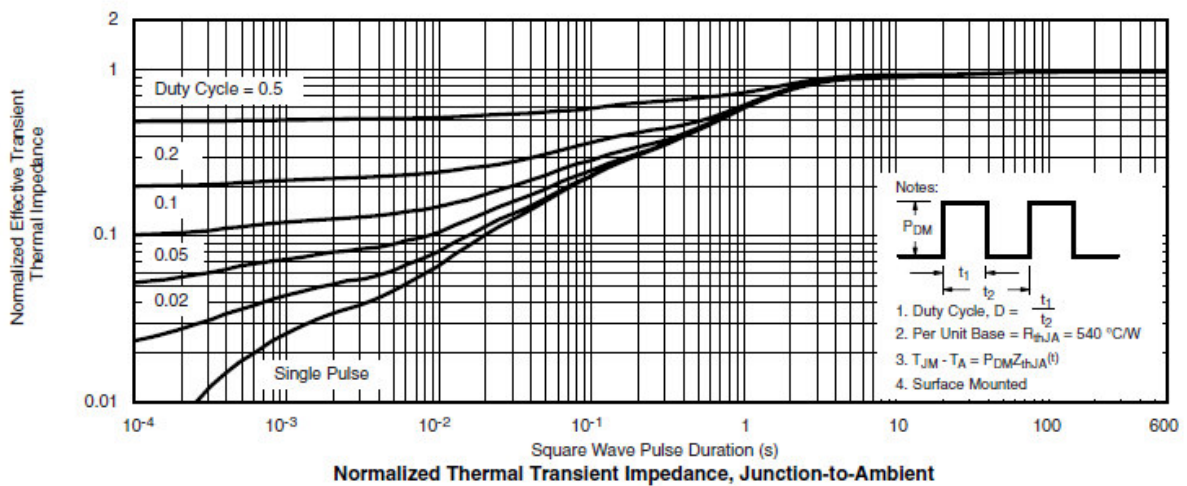
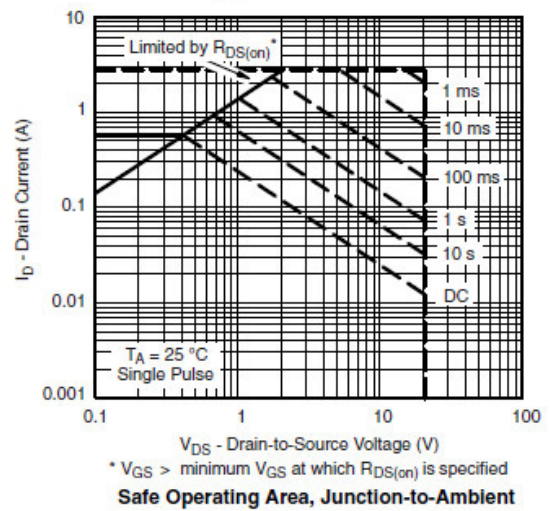
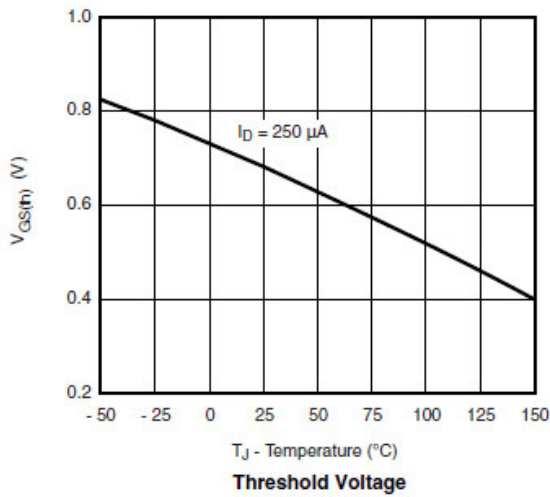
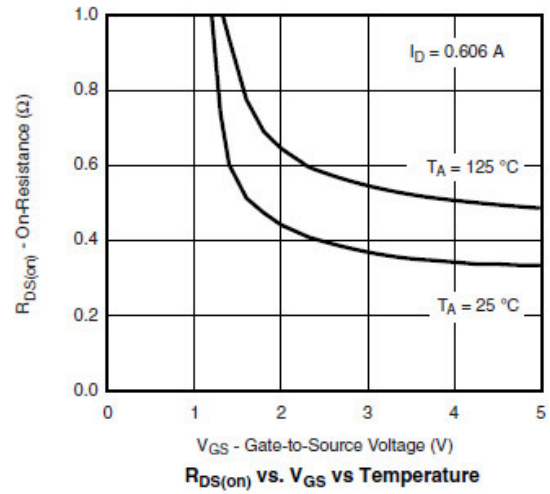
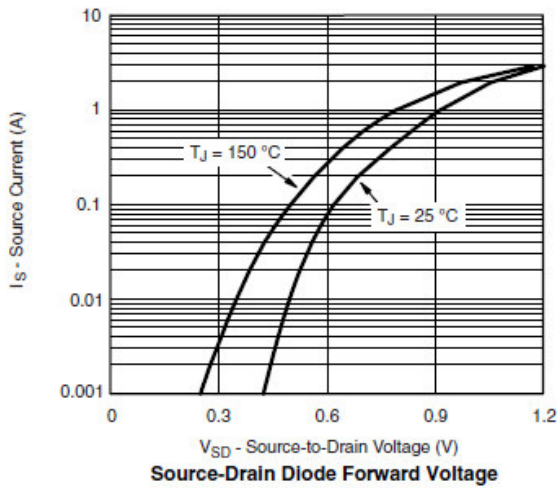

## Typical Characteristics

Gate Charge Test Circuit & Waveform

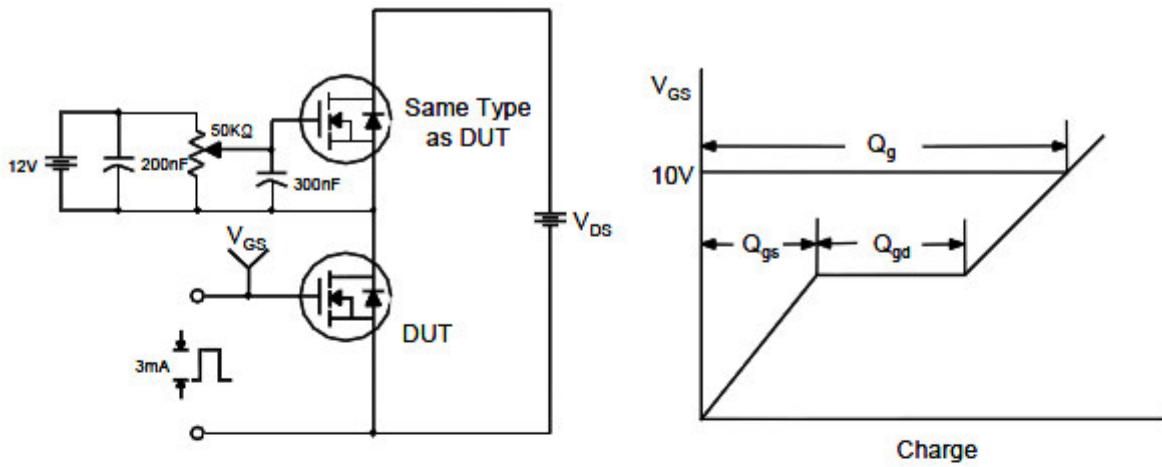

Resistive Switching Test Circuit & Waveforms

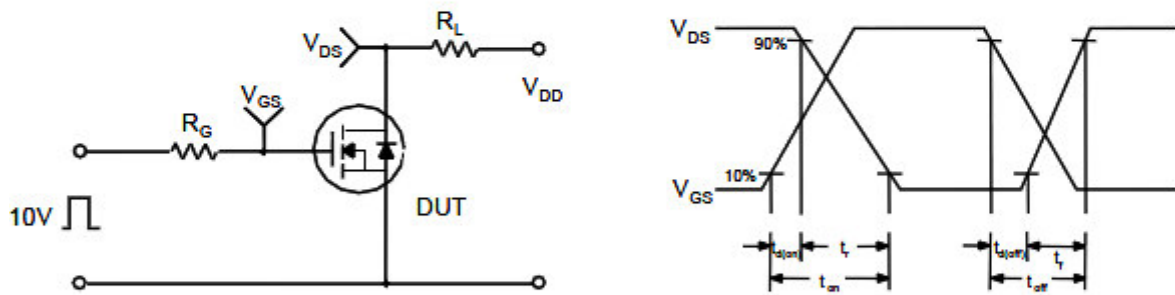

Unclamped Inductive Switching Test Circuit & Waveforms

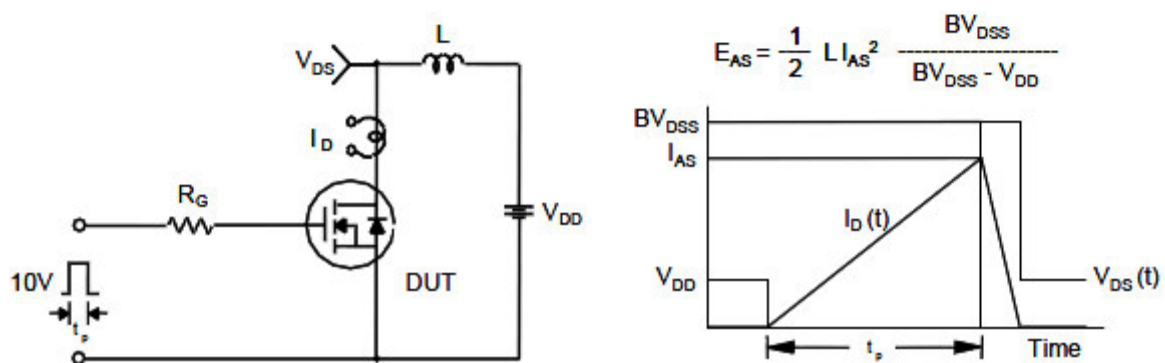

## Package Dimension

### SOT-523

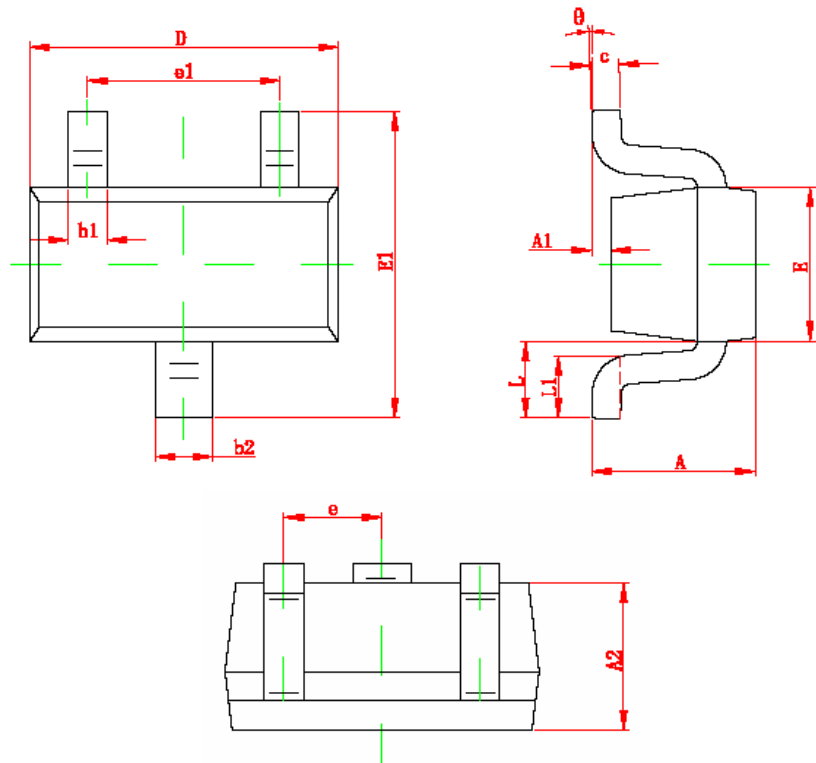





Dimensions				
Symbol	Millimeters		Inches	
	Min	Max	Min	Max
A	0.700	0.900	0.028	0.035
A1	0.000	0.100	0.000	0.004
A2	0.700	0.800	0.028	0.031
b1	0.150	0.250	0.006	0.010
b2	0.250	0.325	0.010	0.013
c	0.100	0.200	0.004	0.008
D	1.500	1.700	0.059	0.067
E	0.750	0.850	0.030	0.033
E1	1.450	1.750	0.057	0.069
e	0.500(TYP)		0.020(TYP)	
e1	0.900	1.100	0.035	0.043
L	0.550(REF)		0.022(REF)	
L1	0.280	0.440	0.011	0.017
θ	0°	4°	0°	4°



## NOTICE

Information furnished is believed to be accurate and reliable. However Globaltech Semiconductor assumes no responsibility for the consequences of use of such information nor for any infringement of patents or other rights of third parties, which may result from its use. No license is granted by implication or otherwise under any patent or patent rights of Globaltech Semiconductor. Specifications mentioned in this publication are subject to change without notice. This publication supersedes and replaces all information without express written approval of Globaltech Semiconductor.



## CONTACT US

GS Headquarter	
	4F.,No.43-1,Lane11,Sec.6,Minquan E.Rd Neihu District Taipei City 114, Taiwan (R.O.C)
	886-2-2657-9980
	886-2-2657-3630
	sales_twn@gs-power.com

Shenzhen Branch(China)	
	1113 B Building, Happiness Washington, Baoan Nan Road, Luohu District, Shenzhen City, China
	0755-22208941
	sales_cn@gs-power.com

RD Division	
	824 Bolton Drive Milpitas. CA. 95035
	1-408-457-0587