

GSLV321

Single Low Voltage, Low Noise, 1.2MHz, Rail-to-Rail Input/Output, General Purpose CMOS Operational Amplifiers

Product Description

The GSLV321 are low voltage CMOS operational amplifiers, low power, low noise, internally frequency compensated CMOS operational amplifiers. It also features wider bandwidth, lower quiescent and lower offset than legacy LMV operational amplifier family.

They operate from a single power supply ranging from +1.8V to +5.5V. Operation from split power supplies is also possible and the low power supply current drain is independent of the magnitude of the power supply voltage.

Features

- Wide power supply range : +1.8V to +5.5V
- Gain-bandwidth product, GBP(typ)=1.2MHz
- Low Noise Voltage Density : $17\text{nV}/\sqrt{\text{Hz}}$
- Low quiescent current per amplifier : $60\mu\text{A}$
- Low input bias current : 1pA
- Low Offset : $V_{os}(\text{typ})=1\text{mV}$, $I_{os}(\text{typ})=1\text{pA}$
- Unity Gain Stable
- Miniature Packages : SC70-5 & SOT-23-5
- RoHS Compliant, 100%Pb & Halogen Free

Applications

- Chargers
- Power supplies
- Industrial: controls, instruments
- Desktops
- Communications infrastructure

Block Diagram

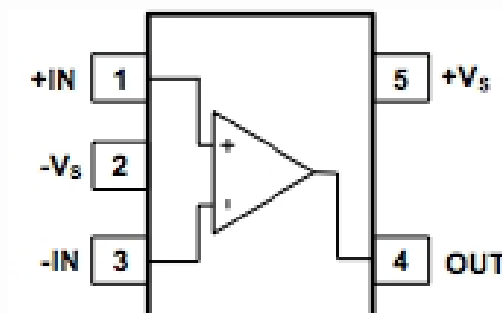

Pin Assignments

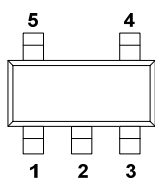
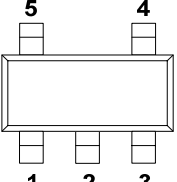
GSLV321X5F (SC70-5) Top View		GSLV321LF (SOT-23-5) Top View	
			
Pin No	Pin Name	Pin No	Pin Name
1	+IN	1	+IN
2	-Vs	2	-Vs
3	-IN	3	-IN
4	OUT	4	OUT
5	+Vs	5	+Vs

Ordering Information

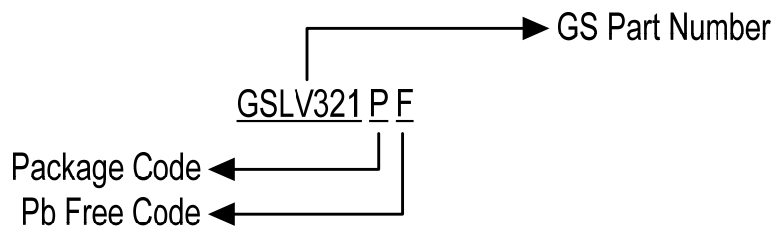

Device	Package
GSLV321X5F	SC70-5
GSLV321LF	SOT-23-5

Marking Information

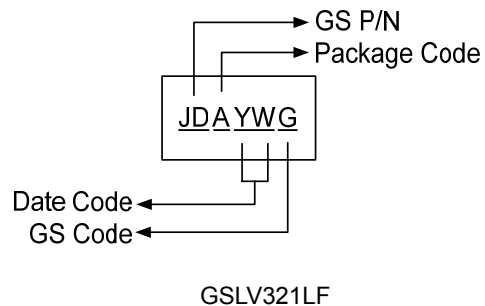
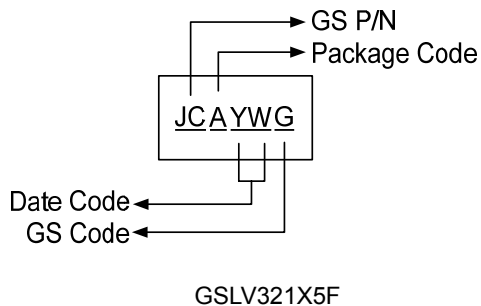

Absolute Maximum Ratings

Symbol	Parameter	Value	Unit
V _{CC}	Supply voltage	7.5	V
V _{IN}	Input voltage	-0.5 to 7.5	V
	Output short-circuit duration	Infinite	
I _{IN}	Input current : V _{IN} driven negative Input current : V _{IN} driven positive above	5mA in DC or 50mA in AC (duty cycle=10%, T=1s)	mA
T _{OPA}	Operating free-air temperature range	-40 to +85	°C
T _{STG}	Storage temperature range	-65 to +150	°C
T _J	Maximum junction temperature	150	°C
θ _{JA}	Thermal resistance junction to ambient	190	°C/W
ESD	Human body mode (HBM)	8000	V
	Machine mode (MM)	400	

Note 1. Stresses beyond those listed under "absolute maximum ratings" may cause permanent damage to the device. These are stress ratings only, and functional operation of the device at these or any other conditions beyond those indicated under "recommended operating conditions" is not implied. Exposure to absolute-maximum-rated conditions for extended periods may affect device reliability.

Note 2. This integrated circuit can be damaged by ESD if you don't pay attention to ESD protection. Recommends that all integrated circuits be handled with appropriate precautions. Failure to observe proper handling and installation procedures can cause damage. ESD damage can range from subtle performance degradation to complete device failure. Precision integrated circuits may be more susceptible to damage because very small parametric changes could cause the device not to meet its published specifications.

Electrical Characteristics

V_S=+5V, T_A=25°C, V_{CM}=V_S/2, R_L=600Ω, unless otherwise noted

Symbol	Parameter	Test Conditions	Min	Typ	Max	Unit
V _{OS}	Input offset voltage			1	3.7	mV
I _B	Input bias current			1		pA
I _{OS}	Input offset current			1		pA
V _{CM}	Common-mode voltage range	V _S =5.5V		-0.1 to +5.6		V
CMRR	Common-mode rejection ratio	V _S =5.5V, V _{CM} =-0.1V to 4V	75	91		dB
		V _S =5.5V, V _{CM} =-0.1V to 5.6V	64	86		dB
A _{OL}	Open-loop voltage gain	R _L =600Ω, V _O =0.15V to 4.85V	70	80		dB
		R _L =10KΩ, V _O =0.05V to 4.95V	75	85		dB
ΔV _{OS} /ΔT	input offset voltage drift			2.1		μV/°C
	Output voltage swing from rail	R _L =600Ω		0.1		V
		R _L =100KΩ		0.015		V
I _{OUT}	Output current		20	25		mA
	Operating voltage range		1.8		5.5	V
PSRR	Power supply rejection ratio	V _S =+2.5V to +5.5V V _{CM} =(-V _S)+0.5V	70	80		dB
I _Q	Quiescent current	I _{OUT} =0A	60	85		μA

Electrical Characteristics (Continue)

$V_S=+5V$, $T_A=25^\circ C$, $V_{CM}=V_S/2$, $R_L=600\Omega$, unless otherwise noted

Symbol	Parameter	Test Conditions	Min	Typ	Max	Unit
GBP	Gain-bandwidth product	$R_L=600\Omega$		1.2		MHz
Φ_o	Phase margin			63.5		deg
BW _P	Full power bandwidth	<1% distortion		400		KHz
SR	Slew rate	G=+1,2V Output step		0.38		V/ μ s
t _s	Settling time to 0.1%	G=+1,2V Output step		0.36		μ s
	Overload recovery time	V_{IN} Gain= V_S		0.4		μ s
	Voltage noise density	f=1KHz		17		nV/ \sqrt{Hz}
		f=10KHz		11		nV/ \sqrt{Hz}

Package Dimension

SC70-5

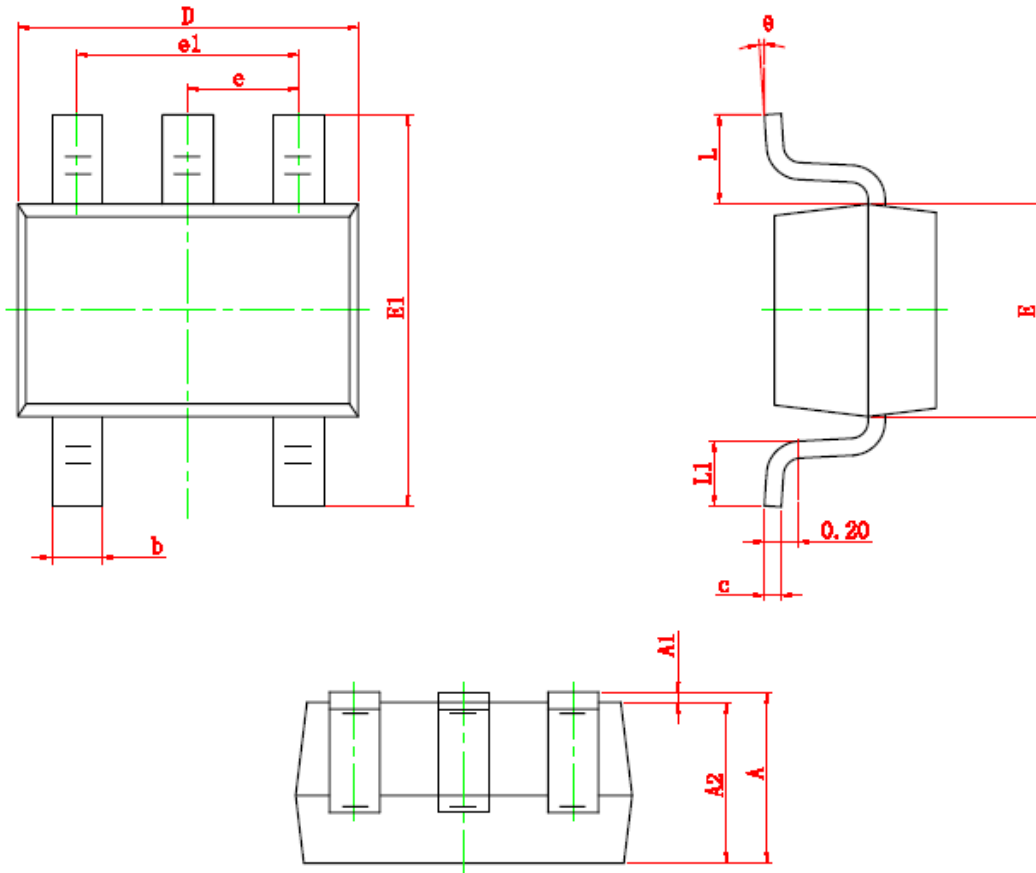

Dimensions

Symbol	Millimeters		Inches	
	Min	Max	Min	Max
A	0.900	1.100	0.035	0.043
A1	0.000	0.100	0.000	0.004
A2	0.900	1.000	0.035	0.039
b	0.150	0.350	0.006	0.014
c	0.080	0.150	0.003	0.006
D	2.000	2.200	0.079	0.087
E	1.150	1.350	0.045	0.053
E1	2.150	2.450	0.085	0.096
e	0.650 TYP		0.026 TYP	
e1	1.200	1.400	0.047	0.055
L	0.525 REF		0.021 REF	
L1	0.260	0.460	0.010	0.018
θ	0°	8°	0°	8°

SOT-23-5

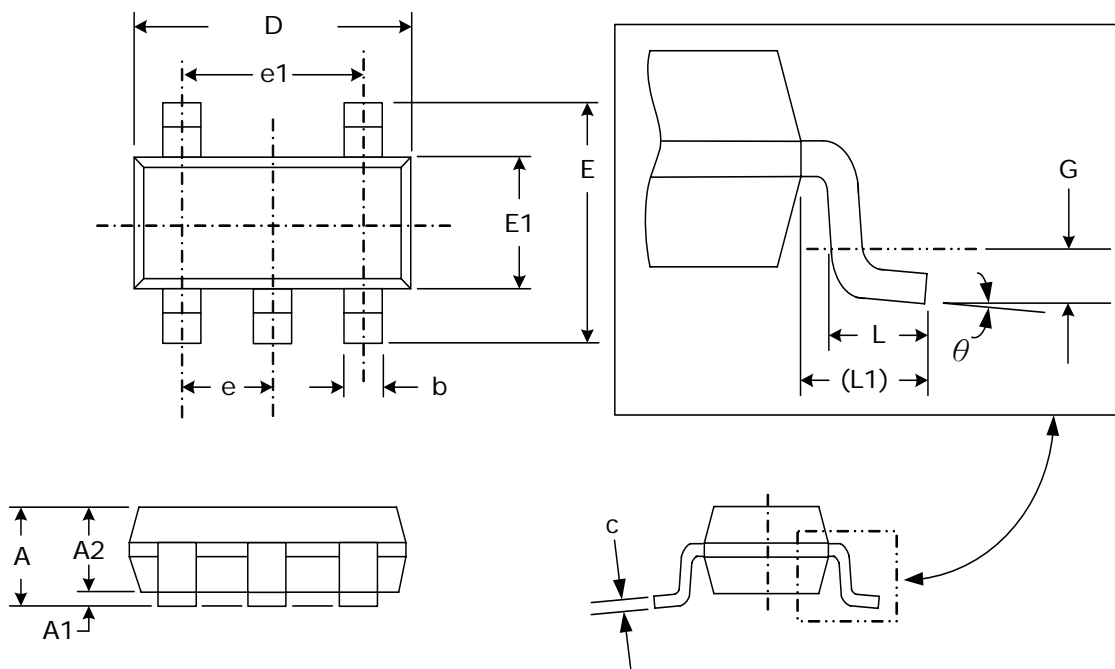





Dimensions				
SYMBOL	Millimeters		Inches	
	MIN	MAX	MIN	MAX
A	0.95	1.45	.037	.057
A1	0.05	0.15	.002	.006
A2	0.90	1.30	.035	.051
b	0.30	0.50	.012	.020
c	0.08	0.20	.003	.008
D	2.80	3.00	.110	.118
E	2.60	3.00	.102	.118
E1	1.50	1.70	.059	.067
e	0.95 (TYP)		.037 (TYP)	
e1	1.90 (TYP)		.075 (TYP)	
L	0.35	0.55	.014	.022
L1	0.60 (TYP)		.024 (TYP)	
G	0.25 (TYP)		.010 (TYP)	
Y	08	88	08	88



NOTICE

Information furnished is believed to be accurate and reliable. However Globaltech Semiconductor assumes no responsibility for the consequences of use of such information nor for any infringement of patents or other rights of third parties, which may result from its use. No license is granted by implication or otherwise under any patent or patent rights of Globaltech Semiconductor. Specifications mentioned in this publication are subject to change without notice. This publication supersedes and replaces all information without express written approval of Globaltech Semiconductor.

CONTACT US

GS Headquarter	
	4F.,No.43-1,Lane11,Sec.6,Minquan E.Rd Neihu District Taipei City 114, Taiwan (R.O.C)
	886-2-2657-9980
	886-2-2657-3630
	sales_twn@gs-power.com

Wu-Xi Branch	
	No.21 Changjiang Rd., WND, Wuxi, Jiangsu, China (INFO. & TECH. Science Park Building A 210 Room)
	86-510-85217051
	86-510-85211238
	sales_cn@gs-power.com

RD Division	
	824 Bolton Drive Milpitas. CA. 95035
	1-408-457-0587