

# GS5420

## High-Efficiency, 2A, 16V Input Synchronous Step-Down Converter

### Product Description

GS5420 develops high efficiency synchronous step-down DC-DC converter capable of delivering 2A load current. GS5420 operates over a wide input voltage range from 4.5V to 16V and integrates main switch and synchronous switch with very low  $R_{DS(ON)}$  to minimize the conduction loss.

GS5420 adopts two operation modes, PWM control and PFM Mode switching control, which allows a high efficiency over the wider range of the load. It operates at 600kHz under heavy load conditions to minimize the size of inductor and capacitor.

The GS5420 requires a minimal number of readily available, standard external components and is available in space-saving SOT-23-6L package

### Features

- 4.5V-16V Input Voltage Range
- 90mΩ/70mΩ Low- $R_{DS(ON)}$  Internal Power MOSFETs
- 2A load current capability
- High Efficiency : up to 96%
- Fast transient responses
- Over Current Protection with Hiccup-Mode
- Two operation modes- PWM control and PFM Mode switching mode
- Tiny SOT-23-6L Package
- RoHS Compliant, 100%Pb & Halogen Free

### Applications

- Set Top Box
- Portable TV
- Access Point Router
- DSL Modem
- Networking

### Functional Block Diagram

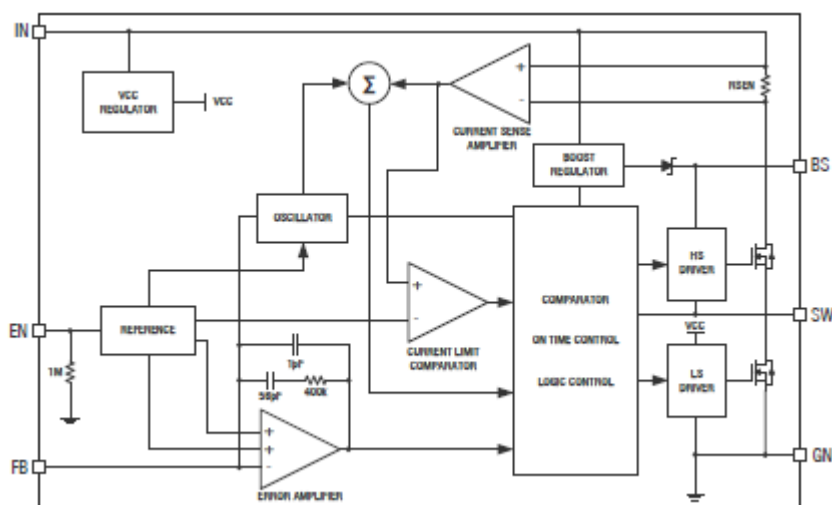

## Packages & Pin Assignments

GS5420RF (SOT-23-6L)	
<p style="text-align: center;">(Top View)</p>	
Pin Name	Description
BS	Boot-Strap Pin. Supply high side gate driver. Decouple this pin to LX pin with 22nF ceramic cap.
GND	Ground pin.
FB	Output Feedback Pin. Connect this pin to the center point of the output resistor divider to program the output voltage:
EN	Enable control. Pull high to turn on, low to disable and enter to shutdown mode.
IN	Power input pin.
LX	Inductor pin. Connect this pin to the switching node of inductor.

## Ordering Information

Part Number	Package	Marking
GS5420RF	SOT-23-6L	A616

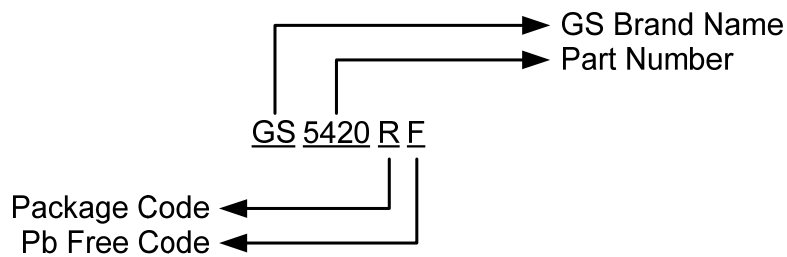

## Absolute Maximum Ratings (Note 1)

Symbol	Parameter	Maximum Rating	Units
V <sub>IN</sub>	Input Voltage	-0.3 to 17	V
V <sub>SW</sub>	Switch Voltage	-0.3 to V <sub>IN</sub> +0.5	V
V <sub>EN</sub>	Enable Voltage	-0.3 to 17	V
V <sub>BS</sub>	Bootstrap Voltage	(V <sub>sw</sub> -0.3V) to (V <sub>sw</sub> +0.5V)	V
V <sub>FB</sub>	Feedback Voltage	-0.3 to +6	V
θ <sub>JA</sub>	Thermal Resistance Junction to Ambient	170	°C/W
θ <sub>JC</sub>	Thermal Resistance Junction to Case	130	°C/W
T <sub>J</sub>	Junction Temperature (Note 2)	+150	°C
T <sub>LEAD</sub>	Lead Temperature (soldering, 10s)	+260	°C
T <sub>STG</sub>	Storage Temperature Range	-65 to +150	°C
ESD HBM	Human Body Mode	2K	V
ESD MM	Machine Mode	200	V
P <sub>D</sub>	Power Dissipation	0.6	W

## Recommended Operating Conditions (Note 3)

Symbol	Parameter	Rating	Units
V <sub>IN</sub>	Input Voltage	4.5 to 16	V
T <sub>A</sub>	Operating Temperature Range	-40 to +85	°C

Note 1 : Exceeding these ratings may damage the device.

Note 2 : T<sub>J</sub> is calculated from the ambient temperature T<sub>A</sub> and power P<sub>D</sub> dissipation according to the following formula: T<sub>J</sub>= T<sub>A</sub> + P<sub>D</sub> \* (170 °C/W)

Note 3 : The device is not guaranteed to function outside of its operating conditions.

## Electrical Characteristics

(V<sub>IN</sub>=12V, V<sub>OUT</sub>=5V, L=4.7uH, T<sub>A</sub>=25°C, unless otherwise specified)

Parameter	Test Conditions	Min	Typ	Max	Units
Input Voltage Range		3.3		16	V
Shutdown Supply Current	V <sub>EN</sub> =0V		1		uA
Supply Current	V <sub>EN</sub> =2V, V <sub>FB</sub> =1.1V		0.4	0.6	mA
Feedback Voltage	4.5V ≤ V <sub>IN</sub> ≤ 16V	588	600	612	mV
High-Side Switch-On Resistance			90		mΩ
Low-Side Switch-On Resistance			70		mΩ
High-Side Switch Leakage	V <sub>EN</sub> =0V, V <sub>SW</sub> =0V		0	10	uA
Upper Switch Current Limit	Minimum Duty Cycle		3.0		A
Oscillator Frequency			600		kHz
Min ON Time			60		ns
Max Duty Cycle	V <sub>FB</sub> =0.6V		92		%
Thermal Shutdown			160		°C

## Typical Application Circuit

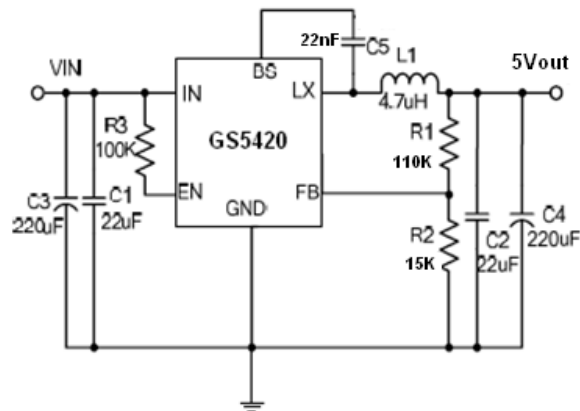

$$V_{OUT} = 0.6 \times \left(1 + \frac{R1}{R2}\right)$$

## Typical Characteristics

Efficiency vs. Load Current

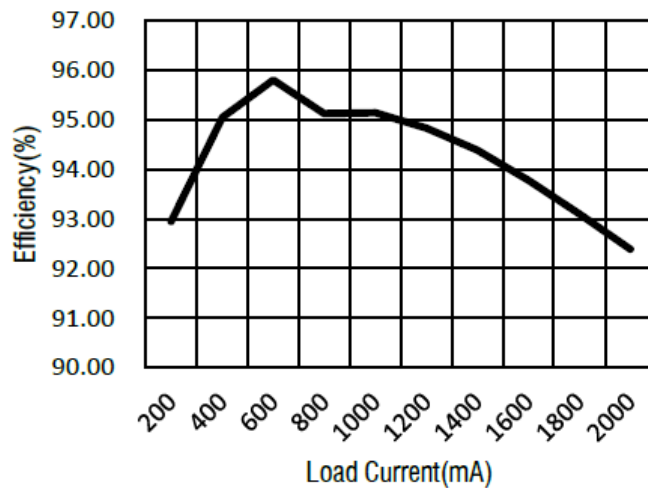

PFM Mode  
( CH1: Vout (ripple) CH2: Vsw )

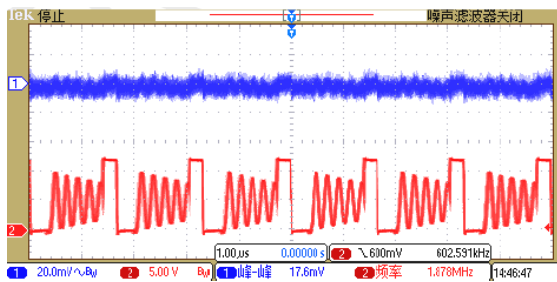

PWM Mode  
( CH1: Vout (ripple) CH2: Vsw )

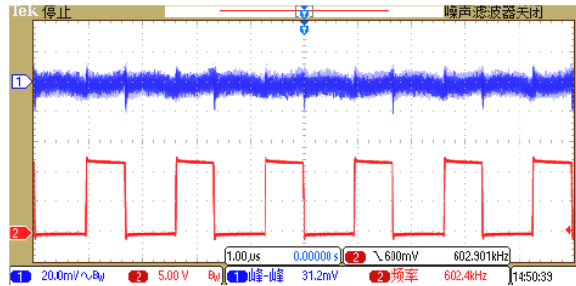

Package Dimension

**SOT-23-6L PLASTIC PACKAGE**

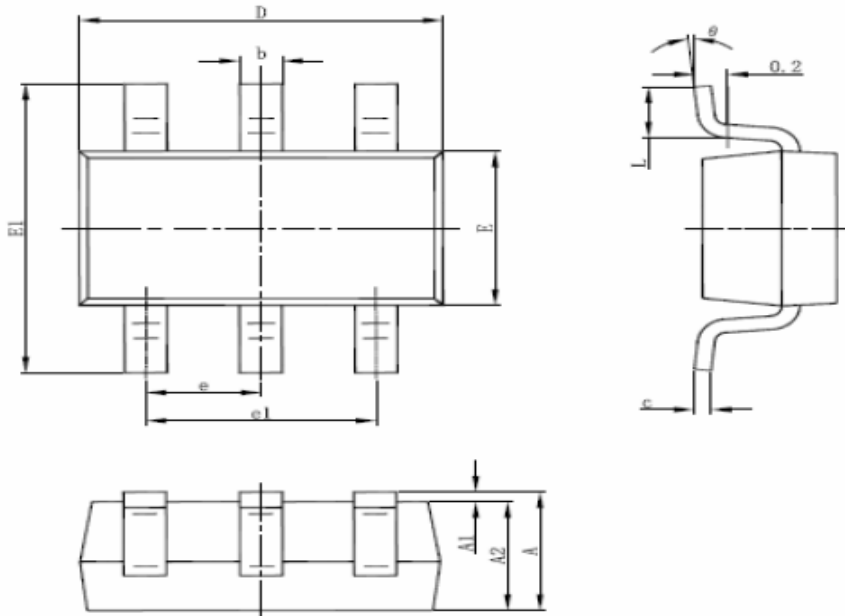



Dimensions				
SYMBOL	Millimeters		Inches	
	MIN	MAX	MIN	MAX
A	1.050	1.45	0.041	0.057
A1	0.000	0.15	0.000	0.006
A2	0.9	1.9	0.035	0.075
b	0.6 (TYP)		0.0236 (TYP)	
c	0.09	0.200	0.0035	0.008
D	2.80	3.020	0.11	0.119
E	1.500	1.700	0.059	0.067
E1	2.60	3.00	0.102	0.118
e	0.950 (BSC)		0.037 (BSC)	
e1	1.800	2.000	0.071	0.079
L	0.300	0.600	0.012	0.024
θ	0°	8°	0°	8°



## NOTICE

Information furnished is believed to be accurate and reliable. However Globaltech Semiconductor assumes no responsibility for the consequences of use of such information nor for any infringement of patents or other rights of third parties, which may result from its use. No license is granted by implication or otherwise under any patent or patent rights of Globaltech Semiconductor. Specifications mentioned in this publication are subject to change without notice. This publication supersedes and replaces all information without express written approval of Globaltech Semiconductor.



## CONTACT US

GS Headquarter	
	4F.,No.43-1,Lane11,Sec.6,Minquan E.Rd Neihu District Taipei City 114, Taiwan (R.O.C)
	886-2-2657-9980
	886-2-2657-3630
	sales_twn@gs-power.com

Shenzhen Branch(China)	
	1113 B Building, Happiness Washington, Baoan Nan Road, Luohu District, Shenzhen City, China
	0755-22208941
	sales_cn@gs-power.com

RD Division	
	824 Bolton Drive Milpitas. CA. 95035
	1-408-457-0587